



STATE OF NORTH CAROLINA
DEPARTMENT OF TRANSPORTATION

MICHAEL F. EASLEY
GOVERNOR

LYNDO TIPPETT
SECRETARY

March 9, 2007

MEMORANDUM TO: 2002 Roadway Design Manual Holders

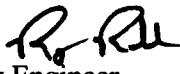
FROM: Rodger D. Rochelle, PE 
State Alternative Delivery Engineer

SUBJECT: 2002 Roadway Design Manual Revision Number 4
and New Guidelines for Revisions

Please find attached revisions and new guidelines to Part I and Part II of the *2002 Roadway Design Manual*. Please insert these revisions in your Manual in the appropriate place. These revisions are effective immediately. This transmittal letter should be detached from the revision and inserted in front of the Manual for future reference. Please recycle discarded pages from your manual. The *2002 Roadway Design Manual* has been updated and is available on the web at:

<http://www.ncdot.org/doh/preconstruct/altern/value/manuals/>

Effective April 2007, approved changes to the *2002 Roadway Design Manual* will be posted to the web site typically within 15 days of receipt by the Special Services Section of the Alternative Delivery Unit. In addition, changes to the *2002 Roadway Design Manual* will also be incorporated into the on-line Manual on their effective date. Supporting engineering documentation will also be included in the electronic version, if applicable. E-mail notification will be provided when changes are posted to the web site and when the on-line Manual is updated.

In order to assist current hard copy users of the *2002 Roadway Design Manual*, hard copies of the revisions will be distributed biannually in April and October and will include all revisions that are effective as of the date of distribution. We anticipate that these new procedures will aid in providing both electronic and hard copy users of the Manual with current, up to date information.

If you have any questions and comments about this revision or the Roadway Design Manual, please contact Mr. Frankie Draper or Mr. Robert McKeithan of my staff at (919) 250-4128.

MAILING ADDRESS:
NC DEPARTMENT OF TRANSPORTATION
ALTERNATIVE DELIVERY UNIT
1591 MAIL SERVICE CENTER
RALEIGH NC 27699-1591

TELEPHONE: 919-250-4128
FAX: 919-250-4119

WEBSITE: WWW.NCDOT.ORG

LOCATION
CENTURY CENTER COMPLEX
ENTRANCE B-2
1020 BIRCH RIDGE DRIVE
RALEIGH NC

2002 Roadway Design Manual Revision Number 4
March 9, 2007
Page 2 of 2

RDR/RM/blj

Attachments

cc:

Mr. Jay A. Bennett, PE

Mr. Jimmy Travis, PE

Mr. Frankie Draper

2002 ROADWAY DESIGN MANUAL - REVISION NO. 4

March 9, 2007

Part I – Roadway Design Manual

1. Chapter 1 – Section 3-F Pavement Alternate Base Course Materials

Add 2 new sheets to this section.

Note: New Section Added to Include Alternate Base Course Materials.

2. Chapter 1 – Section 4-B Usable and Graded Shoulders

Remove and discard 2 sheets and replace with 2 revised sheets.

Note: EOP, Edge of Pavement has been changed to EOT, Edge of Travel Lane.

3. Chapter 1 – Section 6-J Median Crossover Guidelines

Remove and discard 4 sheets and replace with 4 revised sheets.

Note: Directional Crossovers, Median U-Turn Crossovers and Combination added.

4. Chapter 1 – Section 7D Desirable Berm Widths with Sidewalks

Remove and discard 2 sheets and replace with 2 revised sheets.

Note: Changes to Figures 1 and 2.

5. Chapter 5 – Section 2 Masonry Drainage Structures

Remove and discard 2 sheets and replace with 2 revised sheets.

Note: The word “Grated” added and the note (*) changed.

6. Chapter 5 – Section 13 Median Drop Inlets

Remove and discard 1 sheet and replace with 1 revised sheet.

Note: Drop Inlets to be Grated.

7. Chapter 5 – Section 20 Pipe End Treatment Guidelines

Remove and discard 1 sheet and replace with 1 revised sheet.

Note: Grated was added to Drop Inlets

8. Chapter 6 – Section 1 Bridge Policy

Remove and discard 2 sheets and replace with 3 revised sheets.

Note: Rewrite of Approach Slabs.

9. Chapter 6 – Section 6B Bridge Approach Drainage

Remove and discard 1 sheet and replace with 1 revised sheet.

Note: Change to Roadways with Shoulders.

10. Chapter 9 – Section 1 At Grade Intersections

2002 ROADWAY DESIGN MANUAL - REVISION NO. 4

March 9, 2007

Remove and discard 3 sheet and replace with 3 revised sheets.

Note: Changes to Deceleration and Taper Lengths.

11. Chapter 9 – Section 4 Directional Crossovers with Median U-Turns

Remove and discard 1 sheet and replace with 3 revised sheets.

Note: Added new section.

Part II – Roadway Design Manual

1. Chapter 1 Standard Sheets for Plan Preparation

Remove and discard entire Chapter and replace with revised Chapter 1 sheet.

Note: Changed size of work area.

2. Chapter 2 Project Numbers

Remove and discard entire Chapter and replace with revised Chapter 2 sheet.

Note: Total chapter has been removed and left blank.

3. Chapter 3 Title Sheet

Remove and discard entire Chapter and replace with revised Chapter 3.

Note: Total chapter has been revised and updated.

4. Chapter 6 – 1D Pavement Schedule

Remove and discard 2 sheets and replace with 2 revised sheets.

Note: Lift and layer recommendations have been changed.

5. Chapter 9 – 1 Guide for Establishing Proposed Right of Way

Remove and discard 1 sheet and replace with 1 revised sheet.

Note: Buffer area added to berm with curb and gutter on Urban Arterial Projects

6. Chapter 19 – Section 1 Plotting of Cross-section Sheets

Remove and discard 1 sheet and replace with 1 revised sheet

Note: Adjustments to Scales used for Plotting.

7. Chapter 21 – Section 2 Preparation of Public Hearing Maps

Remove and discard 1 sheet and replace with 3 revised sheets

Note: General Update.

Some major new location and existing two lane facilities widened to four lanes will require alternate base course materials. The alternate base course recommendation will allow the contractor the choice to construct either a pavement with aggregate base course or asphalt concrete base course. The Pavement Management Unit will select which projects require alternate base course materials and specify these bases in the pavement design recommendations sent to the Roadway Design Unit.

The roadway typical sections should show the aggregate base course design. Details or insets should supplement the typical sections showing the asphalt concrete base course alternate. (See 1-3F, Figure 1). The Pavement Management Unit will furnish the applicable shoulder drain designs for each alternate design. When coordinating with other units, specify that all work related to Geotechnical Engineering, Hydraulics and Utilities be performed assuming the aggregate base course alternate will be constructed.

Earthwork quantities are required for both alternates. However, plans will include a single earthwork summary based on the aggregate base course alternate with a line item added to the bottom of the earthwork summary showing the differential volumes of the alternate design. Submit a combined balance summary sheet of both alternates to the Geotechnical Engineering Unit for use in preparing subsurface plans (See 1-3F, Figure 1A).

Use the aggregate base course alternate to prepare cross sections with a note on all the cross section summary sheets and the first cross section sheet (in addition to other standard notes) as follows:

“The cross sections reflect the aggregate base course alternate.”

Any pay item quantities affected by the alternate base course materials should be computed and shown on the estimate within the alternate in which they apply. Some possible pay items required to be shown within each alternate are unclassified excavation, borrow excavation (borrow projects), aggregate base course, asphalt concrete, asphalt binder, prime coat and shoulder borrow (waste projects).

PAVEMENT ALTERNATE BASE COURSE MATERIALS

I-3F

F-1

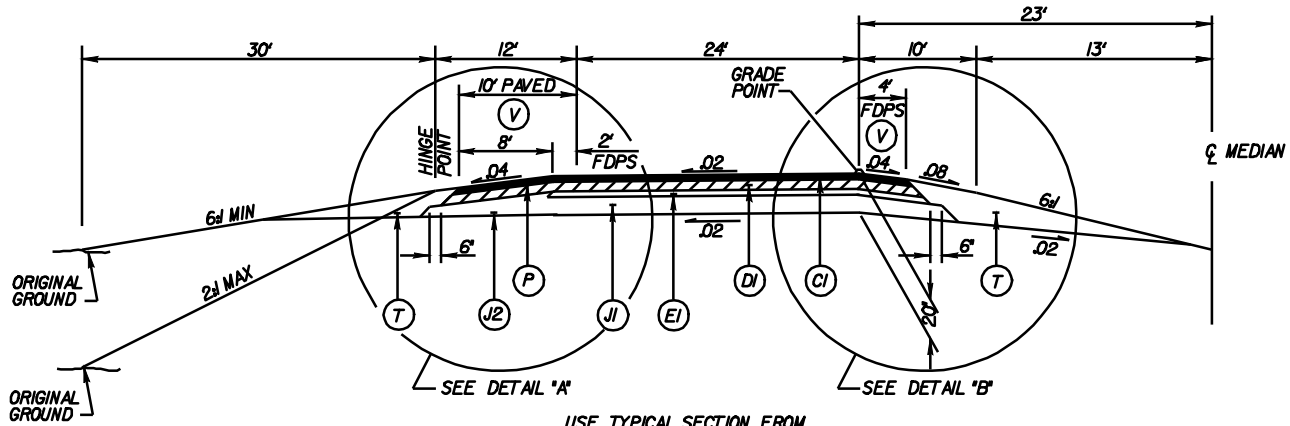

USE TYPICAL SECTION FROM
-L-STA. 65+80.00 TO -L-STA. 67+71.31

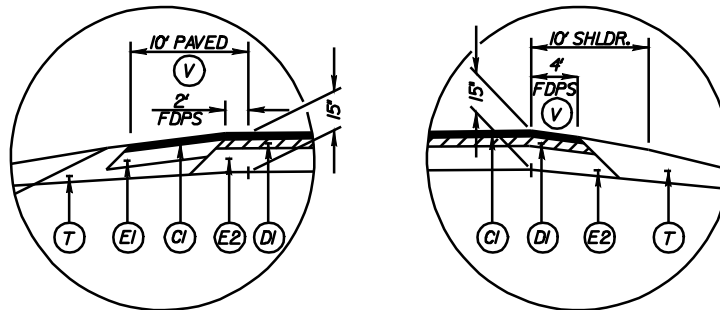

ALTERNATE PAVEMENT DESIGN
DETAIL "A"

ALTERNATE PAVEMENT DESIGN
DETAIL "B"

PAVEMENT SCHEDULE	
(C1)	PROP. APPROX 3" ASPHALT CONCRETE SURFACE COURSE, TYPE S9.5B AT AN AVERAGE RATE OF 168 LBS. PER SQ YARD IN EACH OF TWO LAYERS.
(D1)	PROP. APPROX 4" ASPHALT CONCRETE INTERMEDIATE COURSE, TYPE I19.0B AT AN AVERAGE RATE OF 456 LBS. PER SQ YARD.
(E1)	PROP. APPROX 5" ASPHALT CONCRETE BASE COURSE, TYPE B25.0B AT AN AVERAGE RATE OF 570 LBS. PER SQ YARD.
(E2)	PROP. APPROX 8" ASPHALT CONCRETE BASE COURSE, TYPE B25.0B AT AN AVERAGE RATE OF 456 LBS. PER SQ YARD, IN EACH OF TWO LAYERS.
(J1)	PROP. APPROX 8" AGGREGATE BASE COURSE.
(J2)	PROP. VARIABLE DEPTH AGGREGATE BASE COURSE.
(P)	PRIME COAT AT THE RATE OF 0.35 GALLONS PER SQ YARD.
(T)	EARTH MATERIAL
(V)	RUMBLE STRIP



PROJECT DESIGN NO. F-0250A
SHEET NO. 3-F

STATE OF NORTH CAROLINA
DIVISION OF HIGHWAYS

SUMMARY OF EARTHWORK
IN CUBIC METERS

* PAVEMENT STRUCTURE VOLUME 29,956 Cm

NOTE: Earthwork quantities are calculated by the Roadway Design Unit. These quantities are based in part on subsurface data provided by the Geotechnical Engineering Unit.

DESIGNED BY: A. VOPE DATE: SEP. 2006
CHECKED BY: T. BURN DATE: SEP. 2006

LOCATION	UNCL EXCAVATION	UNDERCUT	EMBT + %	BORROW	WASTE
SUMMARY NO. 1					
-L- 11+98.805 TO 19+00.000	163,668		2,638		161,030
-Y- 10+00.000 TO 13+40.000	3,850		554		3,296
-Y1- 10+00.000 TO 12+26.533	1,395		581		814
-Y1- 13+03.793 TO 14+20.000	507		107		400
-Y1 DET- 10+29.365 TO 14+16.948	2,827		4,504	1,677	
DETOUR REMOVAL			3,062	3,062	
SUMMARY NO. 1 TOTAL	172,247		11,446	4,739	165,540
SUMMARY NO. 2					
-L- 19+00.000 TO 26+17.519 L.B.	24,365		145,723	121,358	
SUMMARY NO. 2 TOTAL	24,365		145,723	121,358	
SUMMARY NO. 3					
-L- 25+77.880 L.A. TO 35+00.000	168,012	1,300	108,846		60,466
-Y2- 10+00.000 TO 13+07.000	5,013		6,870	1,857	
-Y2- 14+20.000 TO 17+39.078	768	600	24,275	23,507	600
SUMMARY NO. 3 TOTAL	173,793	1,900	139,991	25,364	61,066
SUMMARY NO. 4					
-L- 35+00.000 TO 44+00.000	343,420		35,086		308,334
-Y3- 10+00.000 TO 12+26.944	1,633		971		662
-Y3- 13+02.264 TO 14+54.746	1,097		690		407
-Y4- 10+00.000 TO 16+55.785	4,324		26,150	21,826	
-DET2- 12+37.210 TO 15+52.083	5,014		451		4,563
-DET3- 12+51.082 TO 12+95.313	84		0		84
SUMMARY NO. 4 TOTAL	355,572		63,348	21,826	314,050
SUMMARY NO. 5					
-L- 44+00.000 TO 53+00.000	396,205	9,200	54,974		350,476
-Y5- 10+00.000 TO 19+45.115	5,219	800	1,930		4,089
-RFB- 11+53.455 TO 15+26.174	21,810		27,978	6,168	
-RPC- 11+94.366 TO 14+94.366	543		32,014	31,471	
-LPB- 10+67.281 TO 12+51.310	0		62,292	62,292	
-LPC- 10+43.870 TO 12+30.352	5,399		30,973	25,574	
-FY- 12+76.258 TO 18+50.963	45,289		151,585	106,296	
-L- 13+38.426 TO 20+85.589	12,910		17,308	4,398	
-Y6- 21+69.189 TO 28+00.000	25,899		47,316	21,417	
-Y6- 28+00.000 TO 36+00.000	25,504		47,426	21,922	
-Y6- 36+00.000 TO 45+00.000	9,727		106		9,621
-Y6- 45+00.000 TO 49+70.000	1,887		419		1,468
SUMMARY NO. 5 TOTAL	550,392	10,000	474,226	279,488	365,654
PROJECT TOTALS	1,455,802	18,900	1,534,485	79,538	19,755
EST. TO REPLACE TOP					
SOIL ON BORROW PITS					
TOTAL	1,455,802	18,900		9,977	83,515
SAY	1,455,900	18,900		83,600	83,600
PAV'T STRUCTURE VOLUME -L- = 29,956 Cu. Meters					
PROJECT TOTALS	1,471,802	18,900	1,542,513	71,566	19,755
SHOULDER MATERIAL					
ADJ. FOR ROCK WASTE					
SHOULDER MATERIAL					
EST. TO REPLACE TOP					
SOIL ON BORROW PITS					
GRAND TOTALS	1,471,802	18,900		5,578	
SAY	1,472,000			75,144	19,755
PAV'T STRUCTURE VOLUME -L- = 29,956 Cu. Meters					
EARTHWORK TOTALS FOR ALTERNATE PAV'T DESIGN					
SUMMARY TOTALS	1,464,802	11,900	1,464,218	940,439	974,923
ADJ. FOR ALT. PAV'T DESIGN					
ADDITIONAL UNDERCUT	-16,000	7,000	10,122	10,122	-16,000
LOSS DUE TO CLEAR & GRUB	-15,000		8,400	8,400	7,000
ROCK WASTE IN LIEU OF BORROW					
EARTH WASTE IN LIEU OF BORROW					
ADJUSTMENT FOR ROCK WASTE					
SHOULDER MATERIAL					
PROJECT TOTALS	1,455,802	18,900	1,534,485	79,538	19,755
EST. TO REPLACE TOP					
SOIL ON BORROW PITS					
TOTAL	1,455,802	18,900		9,977	83,515
SAY	1,455,900	18,900		83,600	83,600
PAV'T STRUCTURE VOLUME -L- = 29,956 Cu. Meters					

SHOULDERS

1-4

Paved or unpaved shoulders will be based on traffic volume warrants and the pavement composition of the adjacent pavement utilized for the mainline, ramp and etc. Figure 1-4F outlines typical paved shoulder construction. The pavement design report will specify the type of paved shoulder to construct. All utility poles shall be placed outside the Clear Zone as defined by the 2002 Roadside Design Guide.

SHOULDER WIDTHS ON MAINLINE

1-4A

See 1-4B (Figure 1) for usable and graded shoulder widths for local, collector, arterial, interstate and freeway roads.

NOTE: Due to frequent on-shoulder parking and other special design features, Subdivision Roads and Streets shall conform to NCDOT Minimum Construction Standards For Subdivision Roads and may not conform to the above design guidelines.

USABLE AND GRADED SHOULDERS

1-4B

See 1-4B (Figure 1) for usable and graded shoulder widths and their relationship to the overall shoulder width. Shoulders shall not exceed these values unless specified otherwise in the Planning Report or unless approved by the Assistant Head of Roadway Design or the Engineering Coordinator of Design Services.

NOTE: These guidelines apply to new construction, not 3-R projects.

When guardrail is required on a project, additional shoulder width, as noted in Figure 1, is needed for guardrail installation and clearance. At times, this added shoulder width is continued throughout the project for uniformity. As a cost-reduction measure, normal shoulder widths should be specified where guardrail is not required and then transitioned to wider shoulders where guardrail is required. Engineering judgement would be used in considering this method by taking into account the length of the project and the amount of guardrail required.

SHOULDER WIDTHS

LOCALS AND COLLECTORS

IN THE DESIGN OF LOCALS AND COLLECTORS, USE THE FOLLOWING MINIMUM SHOULDER WIDTHS.

ADT	DESIGN YEAR			
	UNDER 400	400 – 1500	1501 – 2000	OVER 2000
LOCALS AND COLLECTORS	2' *	5' **	6'	8'

* WHEN GUARDRAIL IS WARRANTED, THE MINIMUM OFFSET FROM THE EDGE OF THE TRAVEL LANE TO THE FACE OF THE GUARDRAIL IS 4'-0".

** WHERE ENVIRONMENTAL CONSTRAINTS ALLOW, 6-FOOT SHOULDERS SHOULD BE UTILIZED RATHER THAN THE 5-FOOT SHOULDERS.

SEE "A POLICY ON GEOMETRIC DESIGN OF HIGHWAYS AND STREETS", (2001) EXHIBITS 5-5 AND 6-5.

MINIMUM SHOULDER

M = MINIMUM SHOULDER
EOT = EDGE OF TRAVEL LANE

WITHOUT GUARDRAIL

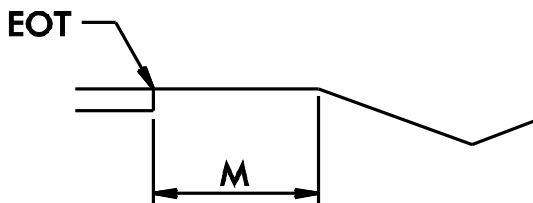

WITH GUARDRAIL

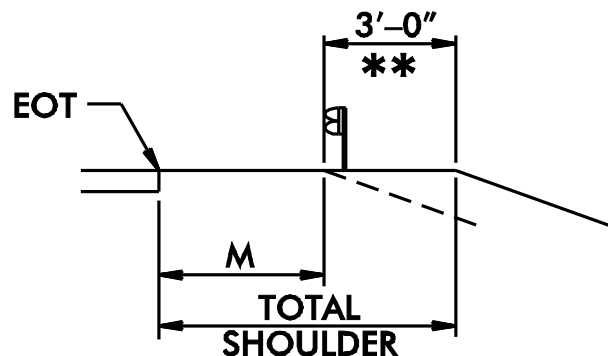

** WHEN GUARDRAIL IS WARRANTED, THE MINIMUM SHOULDER WIDTH IS INCREASED BY 3'-0" AS SHOWN IN THE ABOVE DIAGRAM.

Revision Date 10/2006

Revision No. 4

SHOULDER WIDTHS

ARTERIALS, INTERSTATES, AND FREEWAYS

IN THE DESIGN OF ARTERIALS, INTERSTATES AND FREEWAYS,
USE THE FOLLOWING MINIMUM USABLE SHOULDER WIDTHS.

ADT	DESIGN YEAR			
	UNDER 400	400 – 1500	1501 – 2000	OVER 2000
ARTERIALS	4'	6'	6'	8' **

NOTE: SEE "A POLICY ON GEOMETRIC DESIGN OF HIGHWAYS AND STREETS" (2001), EXHIBIT 7-3.

** 10' ON FREEWAYS, EXPRESSWAYS, AND INTERSTATES AND
12' ON FREEWAYS AND INTERSTATES WHEN TRUCK DHV EXCEEDS 500.

NOTE: SEE ARTERIAL MAP PROVIDED IN THIS MANUAL.

USABLE SHOULDER

U = USABLE SHOULDER
EOT = EDGE OF TRAVEL LANE

WITHOUT GUARDRAIL

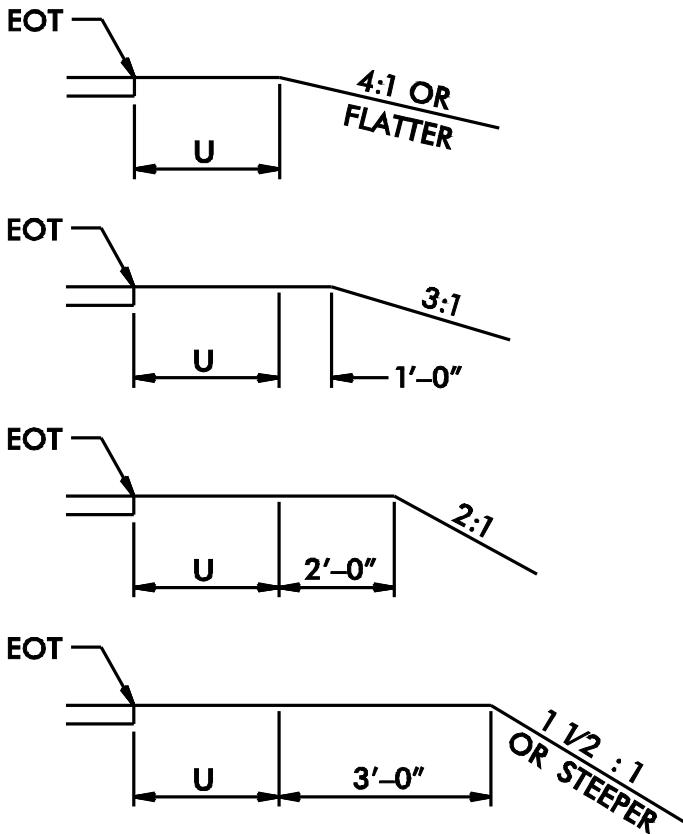

WITH GUARDRAIL

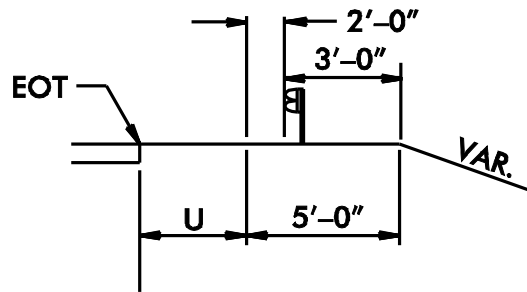

Revision Date 10/2006
Revision No. 4

N.C. DOT PAVED SHOULDER POLICY1-4C

The NCDOT Paved Shoulder Policy incorporates the findings of an in-depth study of construction, maintenance, safety, operational and economic issues related directly to the usage of paved shoulders. The economics of providing a safe overall highway system were also considered in determining an appropriate level of expenditure for this design feature. The resultant policy is a standardized method developed specifically for the purpose of consistently providing acceptable paved shoulder designs for each roadway classification. Engineering judgement may be used to determine the need for a higher type shoulder design than is required by this policy on a case-by-case basis. Usage of paved shoulder widths in excess of the requirements of this policy must be approved by the State Roadway Design Engineer and/or the State Design Services Engineer. See 1-4O, and 1-4O, Figure 1, of this manual for additional information.

SHOULDER WIDTH ON LOOPS1-4D

Inside Shoulder – 14' Des. 12' Min. (Right Side of Traffic)
Outside Shoulder – 12' Des. 10' Min. (Left Side of Traffic)

If pavement widening is required, it shall be placed on the inside of the curve. The 2'-6" concrete curb and gutter is placed adjacent to the inside edge of pavement to control drainage and reduce shoulder maintenance. See Chapter 8-1 of this manual for loop pavement widths.

SHOULDER WIDTHS ON RAMPS1-4E

Inside Shoulder – 12' Des. 10' Min. (Left Side of Traffic)
Outside Shoulder – 14' Des. 12' Min. (Right Side of Traffic)

See Chapter 8-2 of this manual for ramp pavement widths.

MEDIAN SLOPES (continued)

1-6F

- NOTE:
1. For projects with flat grades, variable median slopes that increase the ditch grade to improve longitudinal drainage capability shall be considered.
 2. Ditch slopes should meet "Roadside Design Guide" criteria for preferred ditch sections.

PROPOSED MEDIANS
(New Roadways)

When determining the width and maximum (steepest) slopes of a proposed median, consideration shall be given to the following design criteria:

A - Design Year Traffic Volume and Level of Service

B - Design Speed

C - Clear Zone Requirements "Roadside Design Guide"

D - Adequate Drainage of the Pavement Structure

When optimum median width has been established, the ditch slopes should be set as shown in Part 1-2B, Figure 2A thru 4. In no case shall the slopes be steeper than those specified for existing medians.

NOTE: The important hydraulic role of the median ditch in removing water from the roadway surface and protecting the integrity of the pavement structure cannot be overly stressed. In order to provide adequate drainage, shoulder drains and underdrains shall be considered along with median slopes, which will adequately drain both the roadway surface and subgrade. The Pavement Management Unit will make recommendations to the Roadway Design Unit on a project by project basis.

EARTH BERM MEDIAN PIER PROTECTION

1-6G

With median widths 70' and less, Pier Protection shall be provided. An earth berm, guiderail, or guardrail shall be placed as pier protection, when the median width is 70'. When earth berms are placed, pier footings shall be designed accordingly and slope protection placed according to the applicable standards. An earth berm for pier protection is desirable for medians 70' wide (Roadway Standard Drawings, Std. No. 225.08). If the earth berm is not feasible or cost effective, guardrail or guiderail should be utilized.

Median widths over 80' require no impact protection. For additional information, see 17/2 in the Policy and Procedure Manual. See Roadway Standard Drawings, Std. No. 225.08.

MEDIAN DESIGN ON STRUCTURES

1-6H

See Part I, Chapter 6-4 of this manual.

MEDIANS ON -Y- LINES

1-6I

The type of median to be constructed in interchange area shall be determined early in the design stage. If raised islands are proposed across the structure, this shall be shown on the structure recommendations. See Part I, Chapter 6-6 of this Manual.

MEDIAN CROSSOVER GUIDELINES

1-6J

Median Crossover Guideline Statement

Median divided facilities provide the benefits of separating opposing travel lanes, controlling left turn conflicts, allowing a recovery area for out of control vehicles, and a space for future travel lanes. Research data also concludes that the median divided facilities improve traffic flow (travel speeds), traffic operations (reduces congestion), and traffic safety (lower crash rates), when compared to non-divided facilities. Median crossovers may be necessary on median divided facilities that are not fully access controlled) to allow for additional turning and through movements. A median crossover is defined as any connections of the opposing travel lanes that crosses the median of a divided highway. Median crossover includes directional crossovers, U-turns or all-movement crossovers.

Placement of crossovers should be considered carefully since crossovers introduce conflict points along a divided facility and thus may reduce the safety and capacity of the median divided facility. Therefore, it is important to follow these guidelines when considering the addition of median crossovers. The following guidelines have been developed as a guide for design engineers, traffic engineers, and field personnel when considering the placement or addition of median crossovers. The median crossover guidelines shall be used for all new crossovers, even in the cases where adjacent crossovers were approved under previous guidelines.

Types of Crossover Design

When a crossover is deemed justified by the Department, the only the crossover type that meets the operational and safety needs of the location will be considered. The type of crossover design below is listed from the most desirable to least desirable.

- Use of alternative routes and access: This level uses the existing infrastructure of streets, highways, intersections and existing crossovers to provide the mobility that a proposed crossover would serve.
- Directional Crossovers: A directional crossover provides for left-turns in one direction only. These crossovers are preferred because they provide for the predominant movement and are much safer for the traveling public. This technique provides positive access control on major roadways through the design of median openings to allow only designated movements. Typically, these crossovers only provide for left turns from the major route to the side street. No left turns or straight across movements are allowed from the side street. Where the minimum spacing requirements are not met and there is a defined need for left-turn access, then only a directional crossover will be considered. However, the general guidelines must be met for the directional crossover to be considered.
- Median U-turn Crossovers: Median U-turns allow a vehicle to make a U-turn and do not allow for through movement from a side street or driveway.
- Directional Crossovers with Median U-turns: The combination of these two crossover types may be used on a case to case basis where it is deemed desirable. For more information see Part I – Chapter 9 - 4 – F1 thru F3 for detailed guidelines.
- All-Movement Crossovers: All-movement crossovers provide for all movements at the intersection or driveway. The use of all-movement crossovers is reserved for situations where there is sufficient spacing and other crossover designs cannot adequately meet the operational needs of the location. The use of this crossover design should be limited because it decreases capacity; increases delay and congestion; may increase pollutants from vehicles; and some studies indicate that they have a higher propensity for crashes.

General Guidelines for Median Crossover Installations on New and Existing Facilities:

All proposed median crossovers on existing and new facilities shall be evaluated from an operational and safety perspective. The availability of reasonable alternative routes, access points, existing crossovers, along with the desire to preserve the capacity and safety of the facility shall be considered in all proposed crossovers.

The availability of adequate spacing for a crossover shall be considered when determining if a crossover is justified. However, the availability of adequate spacing alone does not warrant a new crossover.

MEDIAN CROSSOVER GUIDELINES (continued)

1-6J

A median crossover shall only be considered when the Department deems it necessary to service traffic generated by existing (and proposed) roadways, businesses or other development; and this traffic cannot be adequately serviced with the existing crossovers at intersections, reasonable alternative routes or other access points.

It is the requesting party's responsibility to provide the justification, or means to acquire the information for justification, for new crossovers. If this information is not provided, the crossover will not be reviewed or approved.

When the Department has deemed a median crossover is necessary, the only crossover type considered will be that which meets the operational and safety needs of the facility.

A median crossover shall not be allowed unless an adequate length left turn deceleration lane and taper can be provided and the addition of the crossover will not impede the storage requirements of adjacent intersections. Left turn lanes will be installed to serve all non-emergency crossover movements allowed on the divided facility at the time of installation.

When crossovers are considered, U-turns must be adequately accommodated or restricted. If trucks and large vehicles are expected to use the crossover, then design vehicle shall be selected to accommodate these movements.

Median Crossovers shall not be located where intersection sight distance (both vertical and horizontal) cannot meet current NCDOT design criteria.

Median crossovers shall not be placed in areas where the grade of the crossover will exceed 5 percent. Special consideration should be given to the vertical profile of any median crossover that has the potential for future signalization to ensure a smooth crossing from a present or future side street.

While it is desirable to have median widths 23 feet or greater, a median crossover shall not be provided where the median width is less than 16 feet.

Crossovers that require a signal or where there is expected potential for a future signal in an otherwise unsignalized area should be avoided.

The Department retains the authority to close or modify any crossover that it deems to be operationally unsafe to the traveling public.

MEDIAN CROSSOVER GUIDELINES (continued)1-6JMedian Crossover Guidelines for North Carolina Streets and Highways**Interstate and Non-Interstate Highways with Full Control of Access:**

No public-use median crossovers will be allowed.

U-turn median openings for use by authorized vehicles for the maintenance and policing of highway or emergency response can be allowed when an engineering study clearly indicates a need. The spacing of the median openings should abide by the following guidelines:

U-turn median openings can be provided if a need has been determined and that they can be added in a safe location where decision sight distance is available. When adding a crossover, it should be located at least one half mile from any overhead structure and at least one mile from the terminus of a ramp acceleration lane or a deceleration lane. The median crossover should be signed appropriately.

The minimum spacing of adjacent U-turn median crossovers between interchanges is three miles. However, spacing alone is not justification for a crossover.

On urban freeways, the interchange spacing is generally close enough that openings are not warranted. Therefore, U-turn openings are not allowed. In addition, on facilities where acceptable gaps are unlikely due to high ADTs, U-turn openings are not allowed.

**Divided Highways without Full Control Access
(Posted speeds of greater than 45 mph)**

On highways with higher traveling speeds, the potential for more severe crashes is greater. Also, on high-speed facilities, development is usually not as concentrated as on lower speed facilities. In order to maximize the safety of these facilities, crossover spacing is critical.

All-movement crossovers shall not be any closer than **2000 feet** apart on divided highways. However, spacing alone is not justification for a crossover. It must be determined that a crossover addition is needed to meet the operational requirements of the facility. Where this spacing requirement is not met and there is a defined need for left-turn access, then a directional crossover will be considered. However, the general guidelines must be met in order for the directional crossover to be added.

**Divided Highways without Full Control Access
(Posted speeds of 45 mph and less)**

There is usually more demand for median crossovers and the speed limit is lower. Because of the density of the development and lower traffic speeds, it is acceptable to provide a closer spacing of median crossovers. However, the availability of adequate spacing alone is not justification for a crossover. Crossovers must be justified to meet operational and access needs that the existing facility cannot adequately serve. Only the type of crossover that meets the operational, access and safety needs of the facility shall be added. Directional crossovers are preferred where they meet the operational and access needs of the roadway.

The spacing of crossovers will be largely dependent upon the need for adequate storage for left turning vehicles/U-turn vehicles at intersections. **A crossover shall not be placed where it interferes with the storage requirement for existing intersections.**

All-movement crossovers shall not be spaced any closer than **1200 feet** apart on divided highways with posted speed of 45 mph and less. Where this spacing requirement is not met and there is a defined need for left-turn access, then a directional crossover will be considered. However, the general guidelines must be met in order for the directional crossover to be added.

Responsibility of Locating Crossovers on Active Roadway Design Projects:

While a project is in design and during the life of the construction of the project, the Project Engineer and Project Design Engineer will locate the crossovers for the highway. Only crossovers at arterials, major collectors, and major traffic generators will be shown on the hearing maps. The Division Office shall be consulted regarding the level of access management desired for the project.

The engineer in the Highway Design Branch will determine if the crossover is justified and then determine the appropriate crossover design type. Priority will be given to placing median crossovers at existing intersecting streets. After the crossovers are located for existing streets that justify a crossover, the engineer will examine the remainder of the highway facility, along with reasonable alternative routes and access points, to determine if there are any other major traffic generators that require consideration for a crossover. When considering the intermediate crossover locations, the minimum spacing as outlined previously in these guidelines is to be followed. The crossover design that meets the operational, access, and safety requirements will be shown.

All crossovers are subject to the review of the Traffic Engineering and Safety Systems Branch, the Division Office, and the appropriate local officials if applicable.

Some special circumstances may justify the need to deviate from these guidelines. If requests are made for crossovers that deviate from these guidelines, the Traffic Engineering and Safety Systems Branch and the Division Office will review the location of the crossover and offer recommendations. The State Design Engineer will be responsible for granting any exceptions to these guidelines on active design and construction projects. Prior to approval of any contractual agreements for crossovers, all negotiated crossovers must be reviewed and approved by the Traffic Engineering Branch, the Highway Design Branch, Division Office, and the appropriate local officials if applicable.

Some special circumstances may justify the need to deviate from these guidelines. If requests are made for crossovers that deviate from these guidelines, the Traffic Engineering and Safety Systems Branch and the Division Office will review the location of the crossover and offer recommendations. The State Design Engineer will be responsible for granting any exceptions to these guidelines on active design and construction projects. Prior to approval of any contractual agreements for crossovers, all negotiated crossovers must be reviewed and approved by the Traffic Engineering Branch, the Highway Design Branch, Division Office, and the appropriate local officials if applicable.

Final approval or denial of the request shall be the responsibility of the State Traffic Engineer. If any aspect of the requested median crossover deviates from the guidelines, the Traffic Engineering and Safety Systems Branch and the Division Office will confer to determine the necessary action to be taken. The State Traffic Engineer will be responsible for granting any exceptions to the guidelines on existing facilities. The State Traffic Engineer will notify the Division Engineer of the decision reached.

Crossovers Considered for Private Developments on Existing facilities:

A private development that justifies direct access and benefits from an added median crossover will be responsible to construct or fund its installation. In addition, it is the responsibility of the requesting party to provide the justification, or means to acquire the information for justification, for new crossovers. If this information is not provided, the crossover will not be reviewed or approved. The developer will be required to submit a complete set of plans and specify the exact location, design, and construction requirements for the proposed median crossover. Only the type crossover that meets the operational and safety needs of the facility shall be added. Directional crossovers are preferred where the design meets the operational and access needs of the roadway. Approval of such a crossover is subject to a traffic engineering investigation and approval procedures as outlined in these guidelines.

Any drainage facilities required by the construction of the crossover will be installed or funded by the developer or the applicant at their expense. After the construction has been completed in accordance with the Division of Highways requirements and standards, and passes the District Engineer inspection, the Division of Highways will assume ownership and maintenance of the crossover.

Failure to comply with the location, design, or construction requirements will result in the crossover being barricaded or removed until the deficiencies have been corrected at the applicant's expense. Once the Division of Highways assumes the ownership, the median crossover will then be subject to the regulations exercised under the police power of the State.

The Department retains the authority to close or modify any crossover that it deems to be operationally unsafe to the traveling public; or causes undue delay, congestion or adversely impacts traffic operations.

Special Use Crossovers

Median crossovers for special purposes, such as fire protection, ambulance services, etc. shall be considered on an individual basis after a traffic engineering investigation.

Emergency response plans and expected level of need, in addition to the geometric limitations of the facility will be used in consideration for special use crossovers. Approved special use crossovers shall be appropriately designed, delineated, and regulated. However, the availability of adequate spacing alone does not warrant a new crossover.

SIDEWALK 1-7

Sidewalks are warranted on projects in accordance with Pedestrian Policy Guidelines. If sidewalk construction is proposed, it will usually be included in the project planning report.

SIDEWALK WIDTHS 1-7A

Desirable – 5' (residential), 10' (commercial and school routes)

Minimum – 4' (residential), 5' (commercial and school routes)

The above widths are adequate for most projects, but heavy pedestrian traffic may warrant wider widths.

SIDEWALK SLOPE 1-7B

Rises at 0.02 from back edge of curb and gutter.

SIDEWALK THICKNESS 1-7C

Unless unusual conditions are proposed in the planning report, 4" concrete shall be used. See Roadway Standard Drawings, Std. No. 848.01.

BERM WIDTHS WITH AND WITHOUT SIDEWALK 1-7D

The following berm widths show desirable and minimum sections. If sidewalk is not constructed initially but is anticipated, one of these sections shall be constructed. See 1-7D, F-1 for Desirable Widths and 1-7D, F-2 for Minimum Widths.

See 1-7D, F-4 for Detail for Placement of Utility Poles in Curb and Gutter sections posted 45 mph or less.

WHEEL CHAIR RAMPS 1-7E

Curb ramps for the handicapped shall be designed in accordance with a manual entitled "Guidelines Curb Cuts and Ramps for Handicapped Persons". For additional information, see 5/4 in the Policy and Procedure Manual. See Roadway Standard Drawings, Std. No. 848.05 for additional information.

DESIRABLE BERM WIDTHS

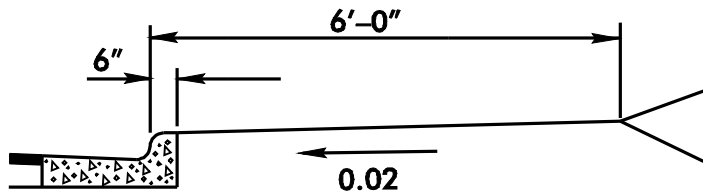
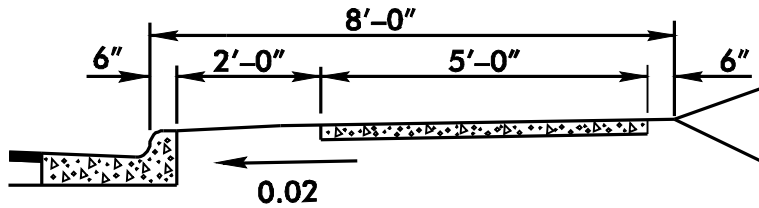
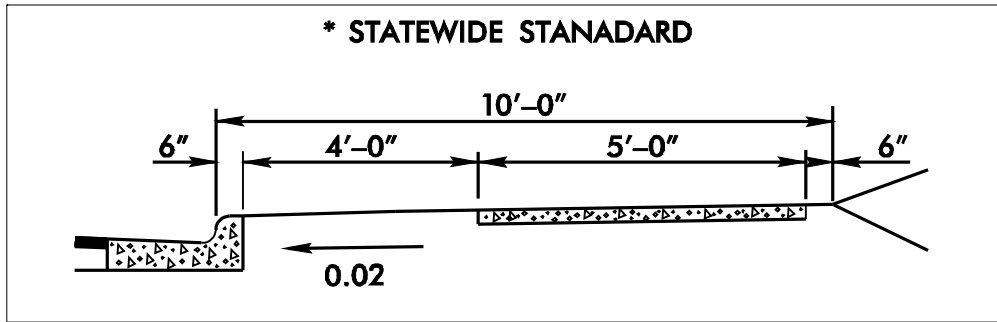
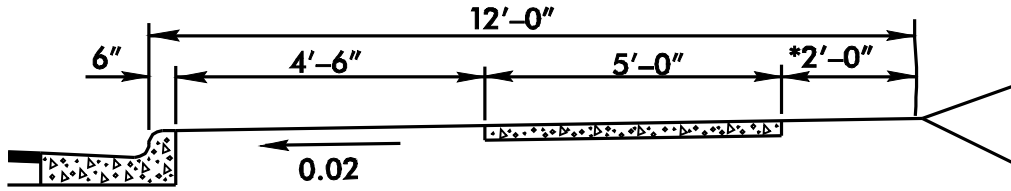

* STATEWIDE STANDARD SHOULD BE USED ON PROJECTS WHERE SIDEWALKS ARE PROPOSED. MORE NARROW BERMS MAY BE USED ON PROJECTS WITH RIGHT-OF-WAY RESTRICTIONS OR TERRAIN CONSTRAINTS. WIDER BERMS MAY BE NEEDED AT GUARDRAIL LOCATIONS (SEE STD. 862.01, SHEET 11 OF 11).

Revision Date 07/01/05
Revision No. 4

MINIMUM BERM WIDTHS

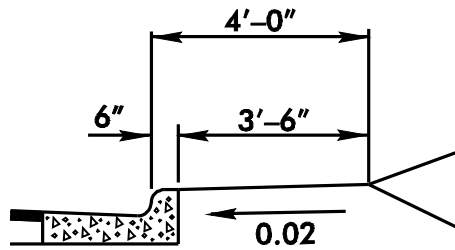
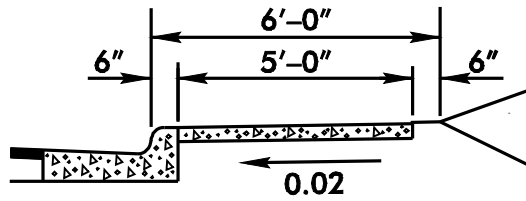
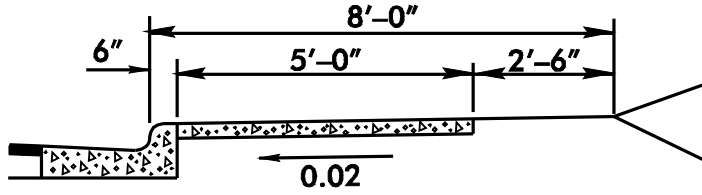
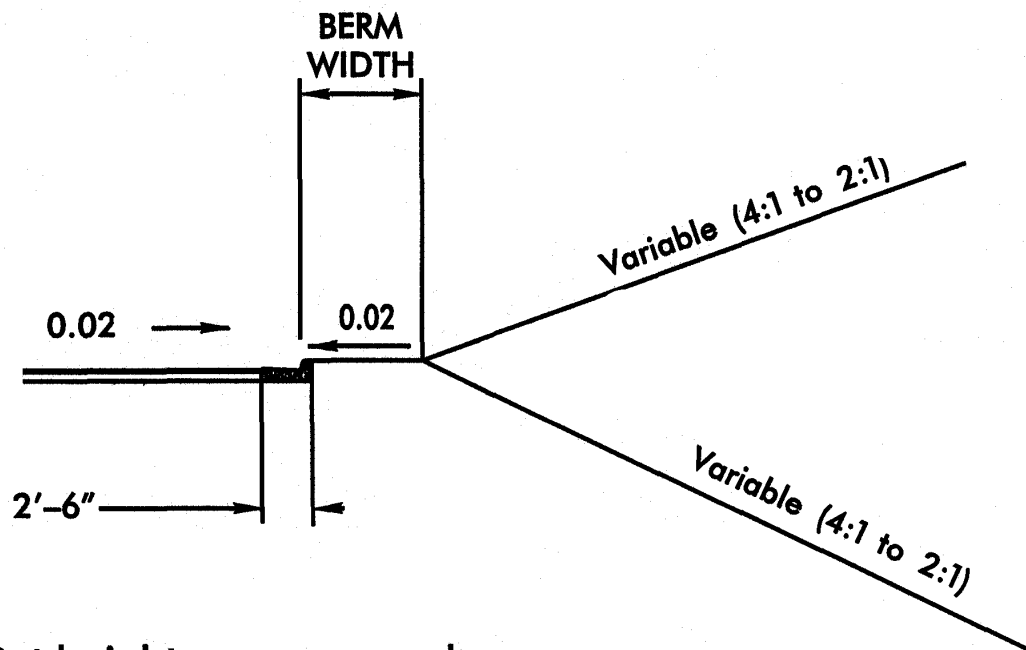

FIGURE 3

1-7D
F-3

Proposed Typical Curb and Gutter Section Statewide



Fill or Cut heights	slope
0-5'	4:1
5'-10'	3:1
>10'	2:1

CHAPTER FIVE

DRAINAGE DESIGN

GENERAL DRAINAGE DESIGN INFORMATION

5-1

Refer to the Roadway Standard Drawings for the standard method of pipe installation, guide for shoulder drain installation, sub-drains, endwalls, catch basins, drop inlets, junction boxes, manholes, pipe end sections and other drainage related items.

Plans requiring step by step approval are to be submitted to the Federal Highway Administration (FHWA) for preliminary approval at the time the drainage design is requested. This procedure will allow the FHWA to comment on basic design elements prior to field review.

MASONRY DRAINAGE STRUCTURES

5-2

Optional types of construction are allowed for catch basins, drop inlets, junction boxes, and manholes. Payment will be made under Section 840 of the Standard Specifications for Roads and Structures, dated January 2002. Any questions and information related to the provisions shall be directed to the Contract Officer. Any questions related to the designs shall be directed to the Plan Review Engineer.

Payment for grates, frames, pipe collars, and pipe plugs will also be made in accordance with Section 840 of the Standard Specifications for Roads and Structures.

When it is necessary to replace or convert an existing drainage structure, documentation of the project file is required. Documentation will be the responsibility of the Hydraulic Engineer.

The following chart specifies construction types permitted and an example of computing quantities is also provided.

MASONRY DRAINAGE STRUCTURES (continued)

5-2

TYPE CONSTRUCTION PERMITTED

STRUCTURE	BRICK	CONCRETE	PRECAST	SOLID BLOCK
Brick Catch Basin Std. 840.01	X			X
Conc. Catch Basin Std. 840.02		X	X	
Conc. Open Throat Catch Basin Std. 840.04		X	X	
Brick Open Throat Catch Basin Std. 840.05	X			X
Conc. Bridge Approach Drop Inlet Std. 840.13		X		
Conc. Drop Inlet Std. 840.14		X	X	
Brick Drop Inlet Std. 840.15	X			X
Conc. Grated D.I., Type "A" Std. 840.17		X	X	
Brick Grated D.I., Type "A" Std. 840.26	X			X
Conc. Grated D.I., Type "B" Std. 840.18		X	X	
Brick Grated D.I., Type "B" Std. 840.27	X			X
Conc. Grated D.I., Type "D" Std. 840.19		X	X	
Brick Grated D.I., Type "D" Std. 840.28	X			X
Driveway Drop Inlet Std. 840.30		X		
*Conc. Junction Box Std. 840.31		X	X	
*Brick Junction Box Std. 840.32	X			X
Traffic Bearing Junction Box Std. 840.34	X		X	X
Traffic Bearing Grated Drop Inlet Std. 840.35		X	X	X
Traffic Bearing Grated Drop Inlet Std. 840.36		X		
Spring Box Std. 840.41	X	X	X	X
Manhole Std. 840.51, 840.52 or 840.53	X		X	X

* Special design junction boxes or manholes will be required if the depth of fill does not fall within the range specified on the NCDOT Roadway Standard Drawings.

MASONRY DRAINAGE STRUCTURES (continued)

5-2

Payment for all of the above structures will be made in accordance with Item 840 - "Masonry Drainage Structures".

* Special Design Junction Boxes or manholes will be required if the depth of fill does not fall within the range specified on the NCDOT Roadway Standard Drawings.

MASONRY DRAINAGE STRUCTURES QUANTITY PER EACH BASIS

5-2A

A drainage structure which incorporates an opening for circular pipe not exceeding 48 inches in diameter will be measured and paid for on a "per each" basis up to a height of 5 feet at the contract price per each for "Masonry Drainage Structures". For an example of figuring quantities for drainage structures, see 5-2C of this Chapter.

MASONRY DRAINAGE STRUCTURES
QUANTITY PER LINEAR FOOT BASIS

5-2B

The portion of a drainage structure from 5.1 feet up to and including 10 feet will be figured and paid for at the contract unit price per linear foot for "Masonry Drainage Structures". The portion of the Drainage Structure above 10 feet shall be measured and paid for at 1.3 times the contract unit price per linear foot for masonry drainage structures. The height of the drainage structures will be measured vertically to the nearest tenth of a foot from the top of the bottom slab to the top of the wall.

For an example of calculating quantities for drainage structures, see 5-2C of this Chapter.

EXAMPLE FOR COMPUTING QUANTITY OF MASONRY DRAINAGE STRUCTURE

* TOTAL LIN. FT. FOR PAY QUANTITY SHALL BE COL. "A" + (1.3 X COL. B)

	QUANTITIES FOR DRAINAGE STRUCTURES			
	PER EACH (0' THRU 5.0')	*LIN. FT.		
		A	B	
		5.1' THRU 10.0'	10.1' AND ABOVE	
HEIGHT OF STRUCTURES				
4.5'	1	-	-	
8.0'	1	3	-	
15.2'	1	5	5.2	
9.0'	1	4	-	
18.0'	1	5	8	
TOTAL	5	17	13.2	
*GRAND TOTAL	5**	35***		

* 17 + (1.3 X 13.2) = 34.2 LIN.FT.
SAY 35 LIN.FT.

PAY ITEMS:
 MASONRY DRAINAGE STRUCTURE 5 EACH **
 MASONRY DRAINAGE STRUCTURE 35 LIN. FT. ***

TABLE 11

5 - 11

STRUCTURAL PLATE STEEL PIPE
6" x 2" Corrugations - Bolted Fabrications Maximum Fill Heights Over Top of Pipe

SIZE	MIN. COVER OVER TOP OF PIPE		0.109" 12 GAGE		0.138" 10 GAGE		0.168" 8 GAGE		0.188" 7 GAGE		0.218" 5 GAGE		0.249" 3 GAGE		0.280" 1 GAGE		0.280" + 1 GAGE	
			CIR.	ELONG	CIR.	ELONG	CIR.	ELONG	CIR.	ELONG	CIR.	ELONG	CIR.	ELONG	CIR.	ELONG	ELONG	ELONG
60	12"		42	42	61	62	70	81	76	93	86	112	96	132	106	144	184	220
66	12"		38	38	49	58	60	74	64	85	72	102	80	120	83	130	168	198
72	12"		35	35	38	51	50	67	53	77	59	93	65	108	71	118	157	181
78	12"		32	32	36	47	44	62	46	71	51	83	55	100	60	109	143	159
84	12"		30	30	35	44	39	57	41	66	45	75	49	95	52	102	131	145
90	12"		28	28	33	40	35	53	37	61	40	72	43	84	45	91	122	133
96	12"		26	26	31	38	33	50	34	58	36	70	39	78	41	82	115	124
102	24"				29	36	31	47	32	54	34	65	36	72	38	75	107	117
108	24"				27	34	29	45	30	51	32	62	34	68	35	70	102	112
114	24"				26	33	28	42	29	48	31	58	32	63	34	65	96	107
120	24"				25	31	27	40	28	46	29	56	30	60	33	62	92	104
126	24"						26	37	26	44	27	52	29	58	30	59	86	100
132	24"						25	36	25	42	26	50	28	56	29	58	83	98
138	24"						24	34	25	39	25	48	27	54	28	55	79	94
144	24"						24	33	25	38	25	46	26	52	27	54	76	92
156	24"						23	31	23	35	24	43	25	50	26	52	70	85
168	24"						23	28	23	33	23	40	24	47	25	50	65	78
180	24"						22	27	22	31	23	37	23	44	24	48	61	73
192	24"						22	25	22	29	23	35	23	41	23	45	57	69
204	36"						22	23	22	27	22	33	22	39	23	42	54	65

* EXCELLENT BACKFILL 95% DENSITY

PIPE CLASSIFICATIONS

5-12

Pipe classifications will be provided by the Hydraulics Unit for cross drains under high type pavement, for special situations, and for storm drains and special drainage systems. (High type pavement is any Portland Cement Concrete Pavement, or any Asphalt Concrete Pavement at least 2" thick.)

For cross drains under low type pavement, the contractor has the option of using either reinforced concrete pipe culverts or bituminous coated corrugated steel pipe culverts unless otherwise specified by the Hydraulics Unit. Pipe alternates shall be shown on the summary sheets.

For driveway pipe through 24", the type of pipe will be optional between plain concrete pipe culverts, HDPE smooth lined corrugated plastic pipe and corrugated steel pipe culverts. Pipe shall be shown on the summary sheets. The above procedure will be followed unless otherwise specified by the Hydraulics Unit.

For temporary detours, use plain C.S. Pipe Culverts.
See 5-12, Figure 1 of this Chapter for a detail showing typical pipe installations.
For additional information on drainage quantities sheets, see Part II, 8-2 of this Manual.

MEDIAN DROP INLETS

5-13

Narrow slot grates (Std. No's. 840.24 & 840.29) : use with grated drop inlets on non-controlled access projects and projects with heavy pedestrian traffic.

Wide slot grates (Std. No's. 840.20 & 840.22) : use with grated drop inlets on controlled access projects; however narrow slot grates (Std. No's. 840.24 & 840.29) will be used at locations that pedestrian traffic is anticipated.

Traffic bearing grated drop inlets (Std. No. 840.36) : use within a traveling lane (detour or permanent). Traffic bearing grated drop inlets (Std. No's. 840.35 or 840.36) shall also be used within 4'-0" of lanes, except when placed in a concrete traffic island.

Steel frames and flat steel grates (Std. No. 840.37) : use where it has been determined that traffic bearing grated drop inlets are needed on controlled access projects in locations that pedestrian traffic is not anticipated. The Work Zone Traffic Control Unit or the Hydraulics Unit may specify other locations where these must be used due to special considerations such as in a travel lane.

Traffic bearing grated drop inlet Std. No. 840.36 is used exclusively with steel frame and grates.

STANDARD CATCH BASINS

5-14

Use type "E", "F", or "G" grates on standard catch basins unless specified otherwise by the Hydraulics Unit and discussed on field inspection with Division personnel. See Roadway Standard Drawings, Std. No. 840.03. Catch Basins, Std 840.01 or 840.02, placed in 2'-6" curb and gutter are suitable for use adjacent to travel lanes.

REV. 4

REV. DATE: 03/01/06

PIPE END TREATMENT GUIDELINES

5-20

The following guidelines apply to TIP projects on the primary system. The guidelines do not apply to the secondary road system.

The criteria provided within this section (5-20) is intended as a "Guide" only. Engineering judgment should be used to determine if a different, but more appropriate, treatment is necessary.

The following guidelines for Pipe End Treatment shall be used in conjunction with the guidelines on clear zone distances. (See Part I, 1-4N, of this Manual to determine clear zone distances.)

Recommended Pipe End Treatments are listed below in order of preferential treatment. (Use the first recommendation listed under each heading if practical.)

A. Pipe End Treatment for Cross Pipes On All Roadways

(For further information, See "Roadway Standard Drawings", Std. No's. 310.03 and 320.03.)

(1) Pipes Outside Clear Zone

Use endwall on inlet end for 36" or over (unless specified otherwise by Hydraulics Unit).

(2) Pipes Inside Clear Zone

a. Extend all pipe beyond clear zone and use endwall on inlet end for 36" or over (unless specified otherwise by Hydraulics Unit).

b. Use a Cross Pipe end section (4:1 slope) for 30" or under. Use guardrail for 36" or over with endwall on inlet end (unless specified otherwise by Hydraulics Unit). On the outlet end, use a Cross Pipe end section (4:1 slope) with safety bars, or protect with guardrail.

B. Pipe End Treatment For Parallel Pipes

(For further information, See "Roadway Standard Drawings", Std. No's. 310.02 and 320.02.)

(1) At Median Crossover Locations

a. Use a grated drop inlet with 10:1 or flatter slopes.

b. At existing locations without sufficient depth for drainage structures, use Parallel Pipe end sections and 6:1 slope.

(2) At Grade Intersections and Driveways

- a. * Multilane Highways with Design Speed greater than 50 mph.
 1. Place all pipe beyond Clear Zone (see Part I, 5-20, F-2 of this Manual) and use an endwall on inlet end of 36" or over (unless specified otherwise by Hydraulics Unit).
 2. On approach ends, use a grated drop inlet with 6:1 or flatter slopes where practicable and where existing or proposed drainage systems are available.
 3. On approach ends, use parallel pipe end section (6:1 slope) for 24" or under and use guardrail for 30" or over. Trailing ends require no special treatment other than endwalls on the inlet end for 36" or over (unless specified otherwise by Hydraulics Unit).
- b. * Multilane Highways with Design Speeds \leq 50 mph and All Two Lane Highways.

No special end treatment is required on two lane highways and multilane highways with design speeds \leq 50 mph. However, endwall placement is required on inlet end for 36" or over unless otherwise specified by Hydraulics Unit.

* Note: This treatment for multilane highways applies to new construction and major reconstruction projects. It does not apply to resurfacing, bridge replacement, or spot safety projects. Pipe end treatment on these type of projects (including private installations) will be the same as existing pipes unless accident history warrants special consideration.

Endwalls shall be constructed perpendicular to the centerline of pipe unless specific site conditions warrant construction of an endwall parallel to the roadway. (See Hydraulics Unit for approval.) It will be necessary to extend the pipe to allow the end of the endwall to tie into the toe of the fill. See Part I, 5-20, F-1 in this Chapter for an example. Any additional backfill material necessary to extend this pipe shall be covered under Section 300 of the Standard Specifications for Roads and Structures. The quantities for the endwalls constructed perpendicular to the centerline of pipe will be based on a 90° skew rather than skew of pipe.

BIKEWAYS

When a bikeway is required, the bridge shall be designed in accordance with AASHTO standard bicycle accommodations and North Carolina Bicycle Facilities Planning and Design Guidelines to give safe access to bicycles where feasible. A minimum handrail height of 54" is required where bicyclists will be riding next to the handrail.

CROSS SLOPE

The cross slope of a bridge deck shall be the same as the approach travel lane cross slope.

In an area of frequent icing, a reduction in superelevation may be in order. This situation will be dealt with on a project-by-project basis.

APPROACH SLABS

Concrete approach slabs shall be constructed at the ends of all bridges. The approach slab shall be the same width as the bridge gutter to gutter width. Additional width (5'-6' minimum) is necessary to accommodate each sidewalk on a structure.

Bridges located on NHS routes and/or carrying a design year ADT greater than 5,000 shall have a 25'-0" approach slab. Otherwise specify a 15'-0" approach slab. The approach slab length shall be measured along the workline.

Flexible approach pavements require both ends of the approach slab to be parallel to the end bent fill face. The approach slab length shall be measured along the workline.

Rigid approach pavements require the roadway end of the approach slab to be perpendicular to the centerline of the roadway. The minimum length shall be measured along the shortest edge. On very wide bridges and/or bridges with a heavy skew, the long edge of the approach slab may become excessive. For such cases limit the length of the longer edge of the approach slab to 50'-0". This may be accomplished by stepping in the approach slab at approach pavement lines while maintaining the minimum dimension.

BRIDGE POLICY (continued)

6-1

Bridges require approach slabs with either sidewalk or a 4" curb (like curb on shoulder berm gutter) along the entire approach slab length.

CURB AND GUTTER

The clear width for new bridges on streets with curb and gutter approaches shall be the same as the curb to curb approach width except where bikeways are carried across the structure; in such instances, AASHTO standard bicycle safety accommodations should be provided.

The 2' gutter widths shown in this policy are based upon the use of the standard 2'-6" curb and gutter. If other curb and gutter widths are used, bridge widths will be adjusted accordingly.

UNPAVED APPROACH

Unpaved low volume roads require 100' of approved asphalt surfacing from the ends of a newly constructed bridge.

This pavement shall be 20' wide and flare to match the approach slab width within the last 10'.

Normally 75' of guardrail is required at each corner of newly constructed bridges on unpaved roadways.

REINFORCED BRIDGE APPROACH FILLS

It is our policy to use reinforced bridge approach fills for all bridges with a few exceptions. The Geotechnical Engineering Unit will provide a letter to the Roadway Project Engineer if it specifically recommends not using the reinforced approach fills.

MEDIANS ACROSS BRIDGES

On a divided highway, separate structures shall be provided unless it can be clearly shown that it is more economical to provide a single structure or a single structure is needed for the maintenance of traffic.

On controlled access facilities and non-controlled divided facilities with design speeds greater than 50 mph, a median barrier should be provided on single structures. Where the approach roadway has a median barrier, the same type of barrier shall be continued across the structure. If there is no median barrier on the approach roadway, some type of barrier should be provided on the structure.

END BENT SLOPES

Generally, end bent slopes at all rivers and streams shall be 1.5:1; however, final consideration of rate of slope and minimum slope protection requirements will depend upon the Hydraulic Design.

At bridges where a railroad passes underneath the roadway, the end bent slope shall normally be 1.5:1 or the same as adjacent cut; however, negotiations with the railroad company may dictate otherwise. At bridges where a railroad passes over the roadway, the end bent embankment slope shall normally be 1.5:1, unless negotiations with the railroad company dictate otherwise.

End bent embankment slopes shall be 1.5:1 on all other bridges going over roads. End bent slopes occurring in cuts shall be at the same rate of slope as the adjacent roadway cut slopes but, generally no flatter than 2:1.

For bridges with large skew angles, there may be no slope transition in two opposing quadrants of the crossing. In this case, the 1.5:1 end bent slope will simply intersect the flatter end bent fill slope. Slope paving transitions will vary from bridge to bridge depending upon skew angle, type of grading around the bridge, pier placement, and the type of structure (single or dual). The Roadway and Structure Project Engineers should confer early in design of each bridge to work out slope protection paving details at each site. Close coordination at this time will also enable correct detailing in roadway plans for paved shoulder tapers, placement of concrete barrier or guardrail, and roadway shoulder and ditch transitions on the bridge approach.

BRIDGE POLICY (continued)

6-1

If the Geotechnical investigation and laboratory results indicate that 1.5:1 slopes will be unstable at any bridge end bent, flatter slopes or special designs will be used as specified by the Geotechnical Engineering Unit.

Any bridge end bent occurring in rock may have a special slope design as specified by the Geotechnical Engineering Unit.

VERTICAL CLEARANCES

Vertical clearances for new structures shall be designed above all sections of pavement including the useable shoulder. Accommodate future lanes and future loops by providing adequate vertical clearance for the future improvements. A note should be included in the Structure Recommendation plans stating the minimum vertical clearance and any accommodations needed for future lanes.

Vertical clearances shall be as shown below. These clearances include a 6" allowance for future resurfacing. An additional 6" range is shown to allow for the flexibility necessary in the coordination of roadway grades with final superstructure depths.

Vertical clearances above these limits must be justified by economics or some vertical control.

1. Over Interstates and Freeways and Arterials
Vertical Clearances – 16'-6" to 17'-0"

Note: "17'-0" to 17'-6" vertical clearance is desirable for structures located over Interstates, Freeways, or Arterials constructed with portland cement concrete pavement. If the pavement type is not known during the preliminary design phase, then the desirable clearance range should apply to structures located over these facilities having design year average daily truck traffic of 5000 or greater."

2. Over Local and Collector Roads and Streets
Vertical Clearance – 15'-0" to 15'-6"
3. Over all Railroads
Vertical Clearance – 23'-0" to 23'-6" or less if approved by Railroads

4. Navigable Waters
The U.S. Coast Guard permit determines the minimum clearances for navigable waters. Clearances over waters not regulated by the U.S. Coast Guard will be determined by negotiations and agreement with the appropriate interests.
5. Normal minimum clearance above design high water should be 2'-0" for all Interstates, Freeways, Arterials, and Secondary Crossings of Major Rivers, 1'-0" for all other roads. Where conditions warrant, less than the above may be permitted.
6. Pedestrian overpasses and sign structures vertical clearance – 17'-0" to 17'-6"

DECK WIDTHS AND HORIZONTAL CLEARANCES

Two primary elements of any bridge are the deck width on the bridge and the horizontal clearance between piers underneath the bridge. For determining these dimensions, the functional classification of highway facilities described in this chapter shall be used.

A study will be made to determine the deck width on any bridge having a high unit cost.

A cost analysis will be made by Structure Design to determine pier necessity and location. The factors included in this analysis are construction cost, maintenance cost, accident cost, future widening potential, for both the mainline and road underneath it, and continuity of section. Consideration should be given to allow sufficient lateral offset for placement of a future greenway, sidewalk, or rail trail where the project Environmental Planning Document has justified the need for additional lateral offset. Structure Design will coordinate with Roadway Design as necessary.

A study will be made at each interchange to insure that adequate sight distance is available. Special attention should be given to the bridge rail design, offset, and the crest vertical curve on the structure so that traffic turning from the ramp has adequate sight distance. See Chapter 8-7 (Required Sight Distance at Terminals of Ramps) of the Roadway Design Manual for required sight distance.

When a ditch section is carried under a bridge, coordination will be necessary in the selection of horizontal openings and roadway typical sections so that piers are not placed in the ditch bottom, but preferably 2' minimum behind the ditch.

BRIDGE APPROACH DRAINAGE6-6B

Bridge approach drainage varies based on the situation in which it must be installed. The most common treatments are:

(1) Roadways with Shoulders

Metal funnel drains, Grated Drop Inlets or Concrete Bridge Approach Drop Inlets are the most common treatments.

Site conditions will determine which treatment is normally specified by the Hydraulics Unit to carry drainage away from the roadway.

(2) Curb and Gutter Roadways

Bridges constructed on curb and gutter roadways are usually drained by drainage systems that the Hydraulics Unit has designed for the approaching roadways.

STRUCTURE ANCHOR UNITS6-6C

Where it is necessary to attach guardrail to structures, close coordination is required between the Roadway Design and the Structure Design Unit at the point of attachment.

When guardrail is anchored to structures, the attachment at each corner shall be specified on the Structure recommendation by the Roadway Design Project Engineer.

A guardrail anchor unit - Type B-77, is normally needed for this installation.

LOW VOLUME ROADS

On low volume roads that are not paved, a distance of 100' from the ends of a newly constructed bridge shall be paved with an approved asphalt surfacing. This paved travel lane shall be 20' in width and flared to match the deck width of the bridge within the last 10' of pavement. The normal length of guardrail required at bridges with unpaved roadways approaching bridge is 75'.

End bent slopes will be paved or stabilized on all bridges over roads and at other locations as stipulated in the Bridge Policy (see 6-1, of this Chapter). End bent slopes beneath bridges will be on 1.5:1 slopes, unless the Soils and Foundation Section specifies a flatter slope; or in the case of railroad and stream crossings, other considerations prevail. Therefore, on bridges over roads, the 1.5:1 end bent slope under the bridge will normally transition each way to the 2:1 (or flatter) side slopes of the bridge approach roadway fill.

The Bridge Policy specifies paving or stabilization only on the 1.5:1 end bent slopes under the bridge. However, the Soils and Foundation Section now emphasizes the need for some type of protection along the adjacent transition slopes until a 1.75:1 slope is reached. If this transition area from 1.5:1 to 1.75:1 cannot be stabilized by landscaping or vegetation, the Soils and Foundation Section will determine the type and limits of slope protection required at each individual bridge site.

For bridges with large skew angles, there may be no slope transition in two opposing quadrants of the crossing. In this case, the 1.5:1 end bent slope will simply intersect the flatter end bent fill slope. Slope paving transitions will vary from bridge to bridge depending upon skew angle, type of grading around the bridge, pier placement, and the type of structure (single or dual). The Roadway and Structure Project Engineers should confer early in design of each bridge to work out slope protection paving details at each site. Close coordination at this time will also enable correct detailing in roadway plans for paved shoulder tapers, placement of concrete barrier or guardrail, and roadway shoulder and ditch transitions on the bridge approach.

Four-inch slope protection or stabilization shall be shown on all structure recommendations except for bridges crossing streams and railroads. See Roadway Standard Drawings, Std. No's. 610.01, 610.02, and 610.03. Slope protection may be provided at stream locations if required by the Hydraulics Unit. The Hydraulics Unit will specify the type to be used and provide a high water elevation. Special details will be required for curb and gutter projects. The Project Engineer, Contracts and Estimates Project Engineer, and the Structure Design Project Engineer shall coordinate these details. For additional information, see 6-10 of this Chapter.

FIGURE 2

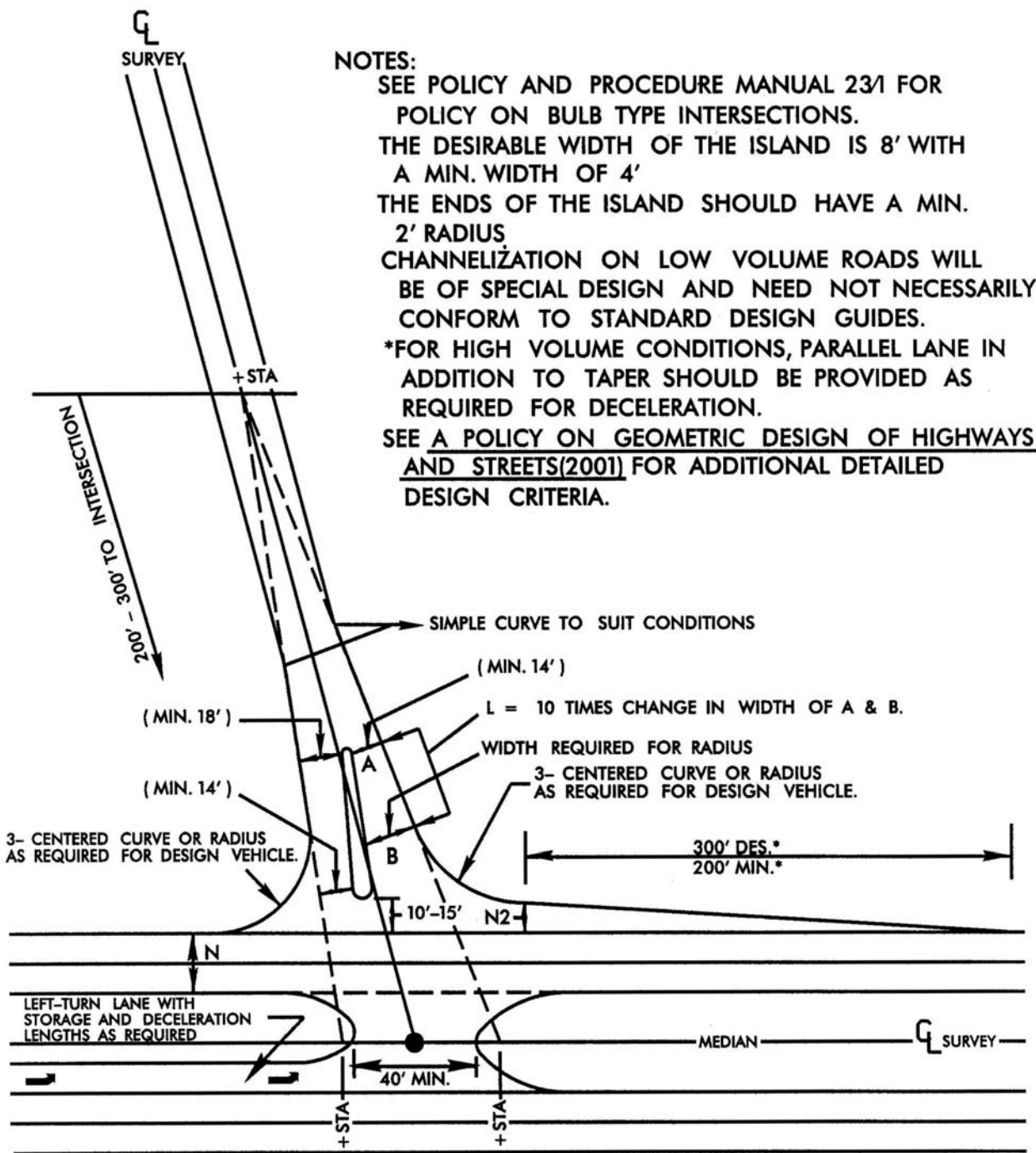

NOTES:

- SEE POLICY AND PROCEDURE MANUAL 23/1 FOR POLICY ON BULB TYPE INTERSECTIONS.
- THE DESIRABLE WIDTH OF THE ISLAND IS 8' WITH A MIN. WIDTH OF 4'
- THE ENDS OF THE ISLAND SHOULD HAVE A MIN. 2' RADIUS
- CHANNELIZATION ON LOW VOLUME ROADS WILL BE OF SPECIAL DESIGN AND NEED NOT NECESSARILY CONFORM TO STANDARD DESIGN GUIDES.
- *FOR HIGH VOLUME CONDITIONS, PARALLEL LANE IN ADDITION TO TAPER SHOULD BE PROVIDED AS REQUIRED FOR DECELERATION.
- SEE A POLICY ON GEOMETRIC DESIGN OF HIGHWAYS AND STREETS(2001) FOR ADDITIONAL DETAILED DESIGN CRITERIA.

DESIGN GUIDE II

INTERSECTION WITH FOUR-LANE DIVIDED FACILITY

DECELERATION LENGTHS FOR MEDIAN CROSSOVERS AND LEFT TURNING MOVEMENTS

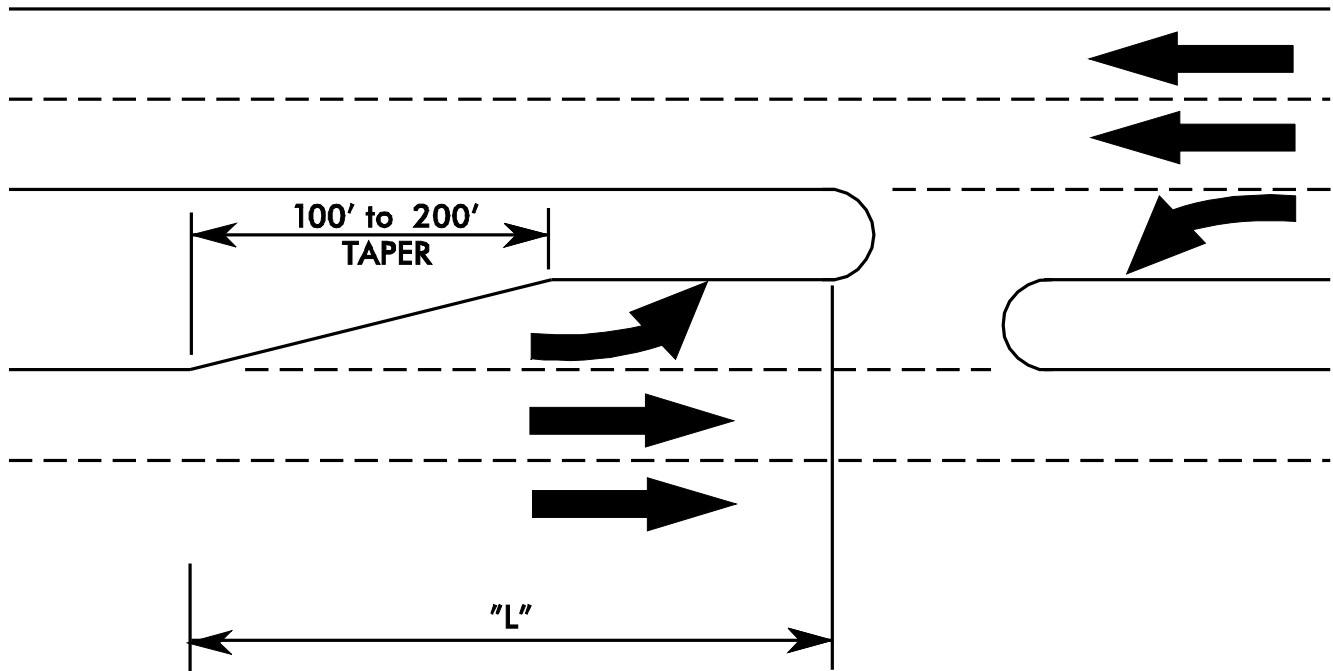

"L" (WHERE VEHICLE STORAGE DOES NOT GOVERN)

NO WAITING VEHICLES

<u>DESIGN SPEED</u>	<u>"L"</u>
40 MPH	330'
50 MPH	550'
60 MPH	680'

**Guidelines for Use of Positive Offset
Left Turn Lanes on Median Divided Facilities**

Positive offset left turn lanes will be required on median divided facilities where the median width is greater than 20 feet and the following criteria is met.

1. Use at all proposed *signalized* intersections which meet either of the following criteria:
 - a. If left turns are designed with exclusive* movements due to inadequate horizontal and/or vertical alignment and there is adequate cross section width available;
 - b. TEE intersections with opposing left turn lanes for U-turn traffic
 2. Use at all *unsignalized* intersections which meet either of the following criteria:
 - a. If 10 year traffic projections satisfy any signal warrants;
 - b. Major route left turns meet or exceed 60 vph during the peak hour
 3. Use at locations where the engineer determines that its use will improve or provide safer or more efficient traffic operations.
 4. Positive offset left turn lanes on median divided facilities should be discussed at the preliminary field inspection.
- * Positive offset left turn lanes will help to enhance exclusive left turn signal operations by reducing the time required for the left turn movements to clear the intersection._____

GUIDELINES FOR OFFSETTING OPPOSING
LEFT-TURN LANES ON DIVIDED ROADWAYS

"L" (WHERE VEHICLE STORAGE DOES NOT GOVERN)

<u>DESIGN SPEED</u>	<u>"L"</u>
40 MPH	330'
50 MPH	550'
60 MPH	680'

GUIDELINES FOR RIGHT TURN LANE WARRANTS, LEFT AND RIGHT TURN LANE STORAGE LENGTHS AND TAPER LENGTH

RIGHT TURN WARRANTS

Figure 4 charts determine the warrants for either a full right turn lane, taper only, or radius only. These charts were taken from NCHRP 279, "Intersection Channelization Design Guide," figure 4-23. They were developed from a 1981 Virginia Highway and Transportation Research Council Report.

LEFT AND RIGHT TURN LANE LENGTHS

Once the right turn warrant has been determined and also figures F-4 A, B, and C determine the minimum turn lane or taper length. The left turn lane lengths were revised to reflect the 2001 AASHTO Design Book. This revision basically excluded the taper from the required deceleration length. These lengths are found in A POLICY ON GEOMETRIC DESIGN OF HIGHWAYS AND STREETS (2001) edition, page 718. There were some concerns raised that these revised lengths (deceleration length plus taper length) were excessive. After reviewing in the field, we agreed. Therefore, we recommended revising the turn lane lengths to the distances shown below which include the taper. The justification for including the taper as part of the deceleration length is found in A POLICY ON GEOMETRIC DESIGN OF HIGHWAYS AND STREETS (2001) edition, page 718. It states: Desirably, the total length of the auxiliary lane should be the sum of the length for these three components (taper plus deceleration plus storage length). Common practice, however, is to accept a moderate amount of deceleration within the through lanes and to consider the taper as part of the deceleration length.

Design Speed	Minimum Right and Left Turn Lane Lengths*	Taper Only For Right Turns
40 mph	330'	230'
50 mph	550'	265'
60 mph	680'	300'

*This length includes the taper. The taper length can range from a minimum of 100' to a maximum of 150'.

AT GRADE INTERSECTIONS (Continued)

9-1

F-4

**GUIDELINES FOR RIGHT TURN LANE WARRANTS, LEFT AND
RIGHT TURN LANE STORAGE LENGTHS AND TAPER LENGTH (Continued)**

The turn lane lengths have been discussed with the FHWA and no design exceptions are required for the above lengths. As with any guidelines, there will be exceptions based on site conditions and engineering judgement. However, these guidelines should provide some overall consistency.

FIGURE 4

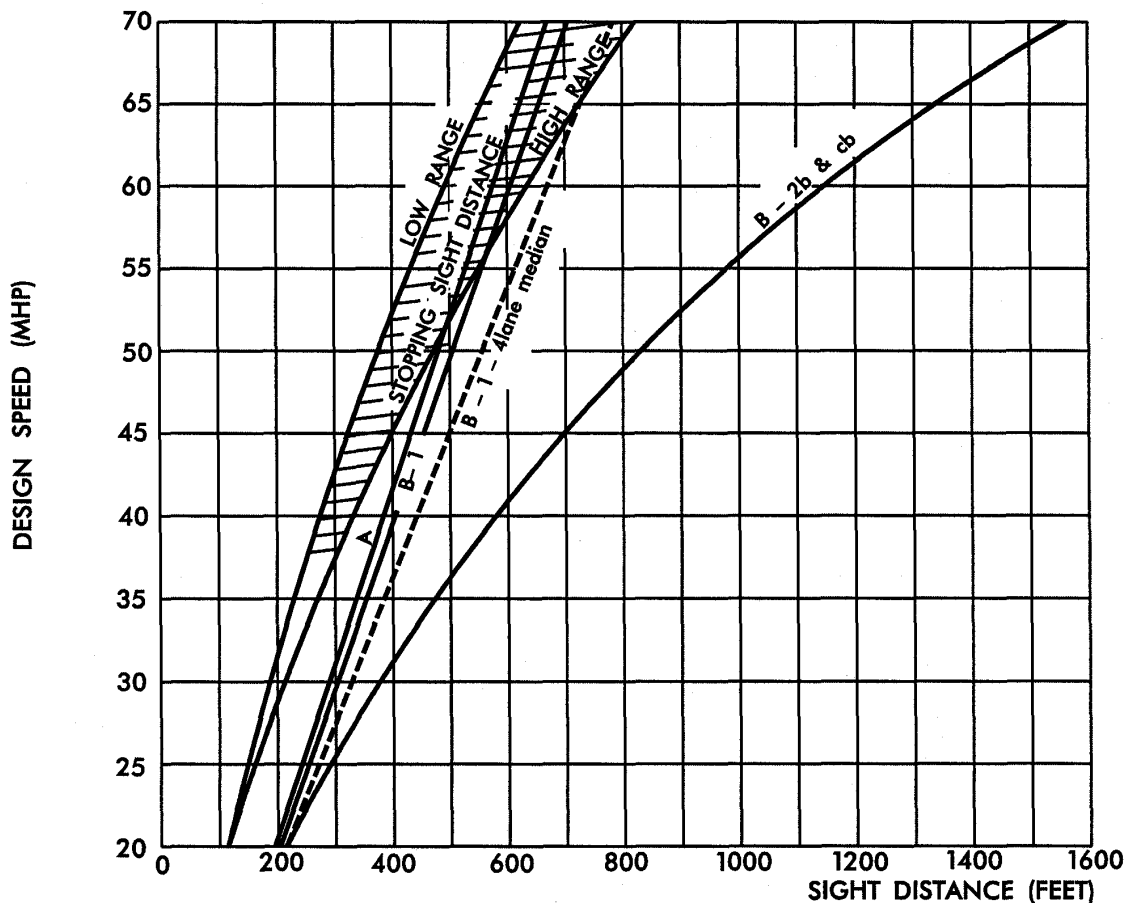
9 - 3
F - 4

INTERSECTION SIGHT DISTANCE AT AT-GRADE INTERSECTION
(CASE IIIB AND CASE IIIC).

- A - SIGHT DISTANCE FOR P VEHICLE CROSSING 2-LANE HIGHWAY FROM STOP. (SEE DIAGRAM)
- B - 1 - SIGHT DISTANCE FOR P VEHICLE TURNING LEFT INTO 2-LANE HIGHWAY ACROSS P VEHICLE APPROACHING FROM LEFT.(SEE DIAGRAM)
- B - 1 - 4LANE +MEDIAN SIGHT DISTANCE FOR P VEHICLE TURNING LEFT INTO 4- LANE HIGHWAY ACROSS P VEHICLE APPROACHING FROM LEFT. (SEE DIAGRAM)
- B - 2b - SIGHT DISTANCE FOR P VEHICLE TO TURN LEFT INTO 2 - LANE HIGHWAY AND ATTAIN 85% OF DESIGN SPEED WITHOUT BEING OVERTAKEN BY A VEHICLE APPROACHING FROM THE RIGHT REDUCING SPEED FROM DESIGN SPEED TO 85% OF DESIGN SPEED.(SEE DIAGRAM)
- cb - SIGHT DISTANCE FOR P VEHICLE TO TURN RIGHT INTO 2 - LANE HIGHWAY AND ATTAIN 85% OF DESIGN SPEED WITHOUT BEING OVERTAKEN BY A VEHICLE APPROACHING FROM THE LEFT REDUCING SPEED FROM DESIGN SPEED TO 85% OF DESIGN SPEED.

DIRECTIONAL CROSSOVERS WITH MEDIAN U-TURNS

9-4

Directional Crossovers with Median U-Turns should be considered in the following locations:

- High speed rural median divided facilities
- Strategic Highway Corridors with partial or limited control of access
- Intersections with a documented crash history
- In congested areas where it is desirable to minimize the use of traffic signals.

The directional crossover eliminates full-movement median openings. Traffic on the primary highway is not affected, as all movements (thru, left, right) are still permitted. Traffic on the secondary highway must turn right onto the primary highway. Through and left movements from the secondary highway are directed to a median U-turn crossover located downstream (approximately 800-1000 ft.)

This type of crossover design will be used in various situations. For rural, high speed median divided facilities, full-movement median crossovers have a high crash potential, with the predominate crash-type being the secondary highway far-side angle crash, which has the potential to have the most severe injuries. The directional crossover with median U-turns converts the secondary highway left-turn and through movements to two-stage movements, (right-turn and U-turn) each of which is significantly safer than the full-movement crossover. Because turning movements are separated the need for signalization at intersections is reduced.

For high-mobility corridors, including strategic highway corridors, the use of directional crossovers with median U-turns converts four-leg, multi-phase signalized intersections into four independent two-phase signalized intersections. The reduced number of signalized phases provides for more green time to be allocated to the primary movements, and allows for shorter cycle lengths, which reduce queuing. Each two-phase signal only impacts one direction of traffic on the primary highway. Because the primary highway's through movements operate independently, signal coordination is simpler and more effective, as the primary highway has effectively been converted to two parallel one-way streets.

Variations include not permitting the primary highway left-turn to turn directly to the secondary highway, diverting that movement to the median U-turn. This may occur where shorts weaving and merging distances at the directional crossover may create a safety or capacity problem. For higher volume secondary highways, or for intersections of two primary highways, another variation would permit the through and right movements from each highway to occur at a two-phase signal, but direct all left-turn movements to median U-turns. This is commonly known as a "Michigan Left" intersection.

DIRECTIONAL CROSSOVERS WITH MEDIAN U-TURNS(continued) 9-4

Each intersection on a corridor must be evaluated individually, to determine the optimum type of median opening. On current TIP projects, the locations where Directional Crossovers with Median U-turns are proposed should be thoroughly discussed during the public hearing map review, presented at the public hearing, and the details of the design features should be discussed during the Final Design Field Inspection. Potential retrofit locations should be reviewed by the Division Traffic Engineer and the Traffic Engineering Branch.

DIRECTIONAL CROSSOVER WITH MEDIAN U-TURNS

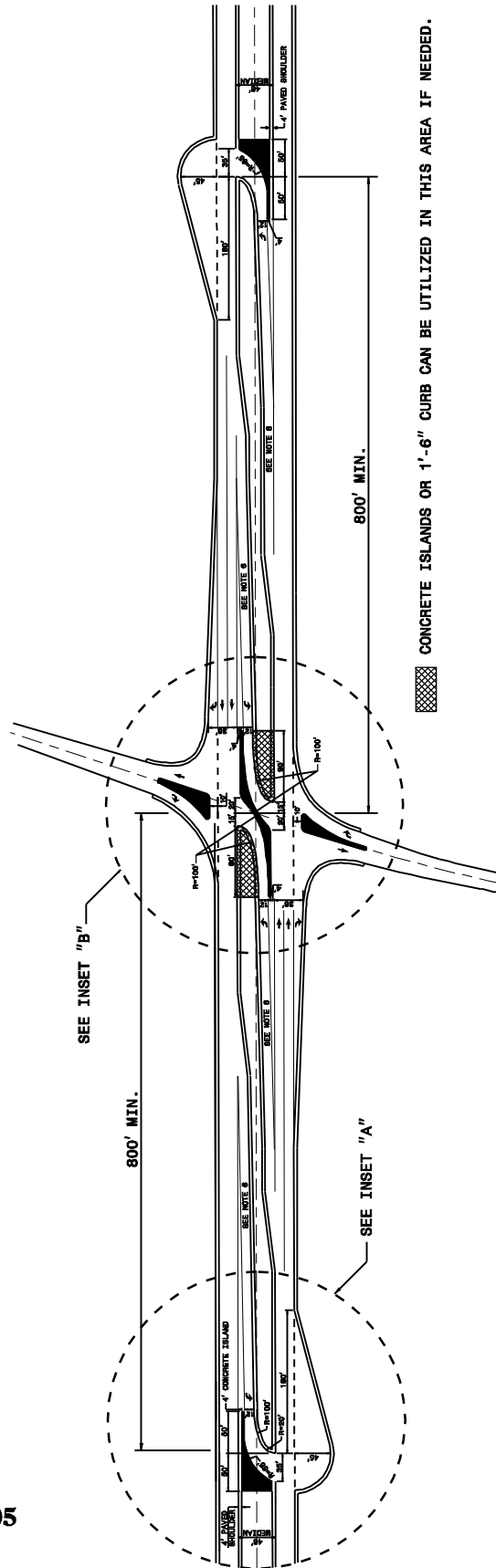

CONCRETE ISLANDS OR 1'-6" CURB CAN BE UTILIZED IN THIS AREA IF NEEDED.

NOTE:

1. THIS DRAWING SHOWS A DESIGN FOR A 46' MEDIAN WITH 4' PAVED SHOULDERS (MEDIAN AND OUTSIDE) ASSUMING A 55 MPH POSTED SPEED. WHEN OTHER MEDIAN WIDTHS, PAVED SHOULDERS, AND POSTED SPEEDS ARE USED, ENGINEERING JUDGEMENT SHOULD BE USED TO ESTABLISH APPROPRIATE GEOMETRY.
2. AT -Y- LINES ONLY PASSENGER CAR U-TURNS ARE ACCOMMODATED.
3. DESIGN BULB OUTS TO ACCOMMODATE WB-50. IN AREAS WHERE THERE ARE R/W OR ENVIRONMENTAL CONSTRAINTS, BULB OUT DIMENSIONS MAY BE REDUCED.
4. ALL DIMENSIONS ARE SUBJECT TO FIELD CONDITIONS.
5. FULL CONTROL OF ACCESS SHOULD BE OBTAINED THROUGHOUT LIMITS OF THE BULB OUT ON BOTH SIDES OF ROADWAY.
6. USE 575' MINIMUM LENGTH FOR ALL LEFT TURN LANES (INCLUDES TAPER AND FULL STORAGE LENGTH).

PLAN

Revision Date 12/01/05
 Revision No. 4

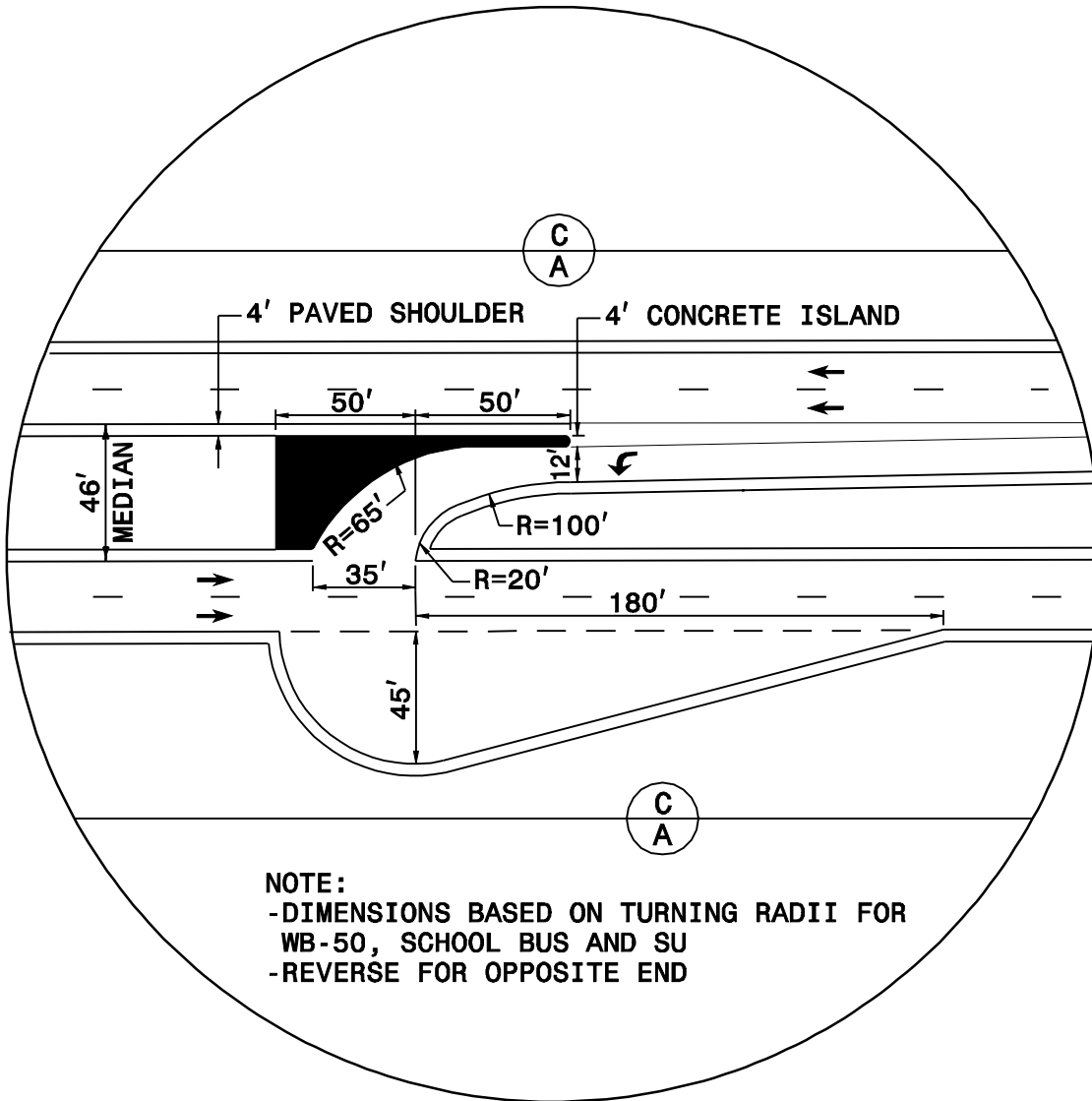

INSET "A"

Revision Date 12/01/05
Revision No. 4

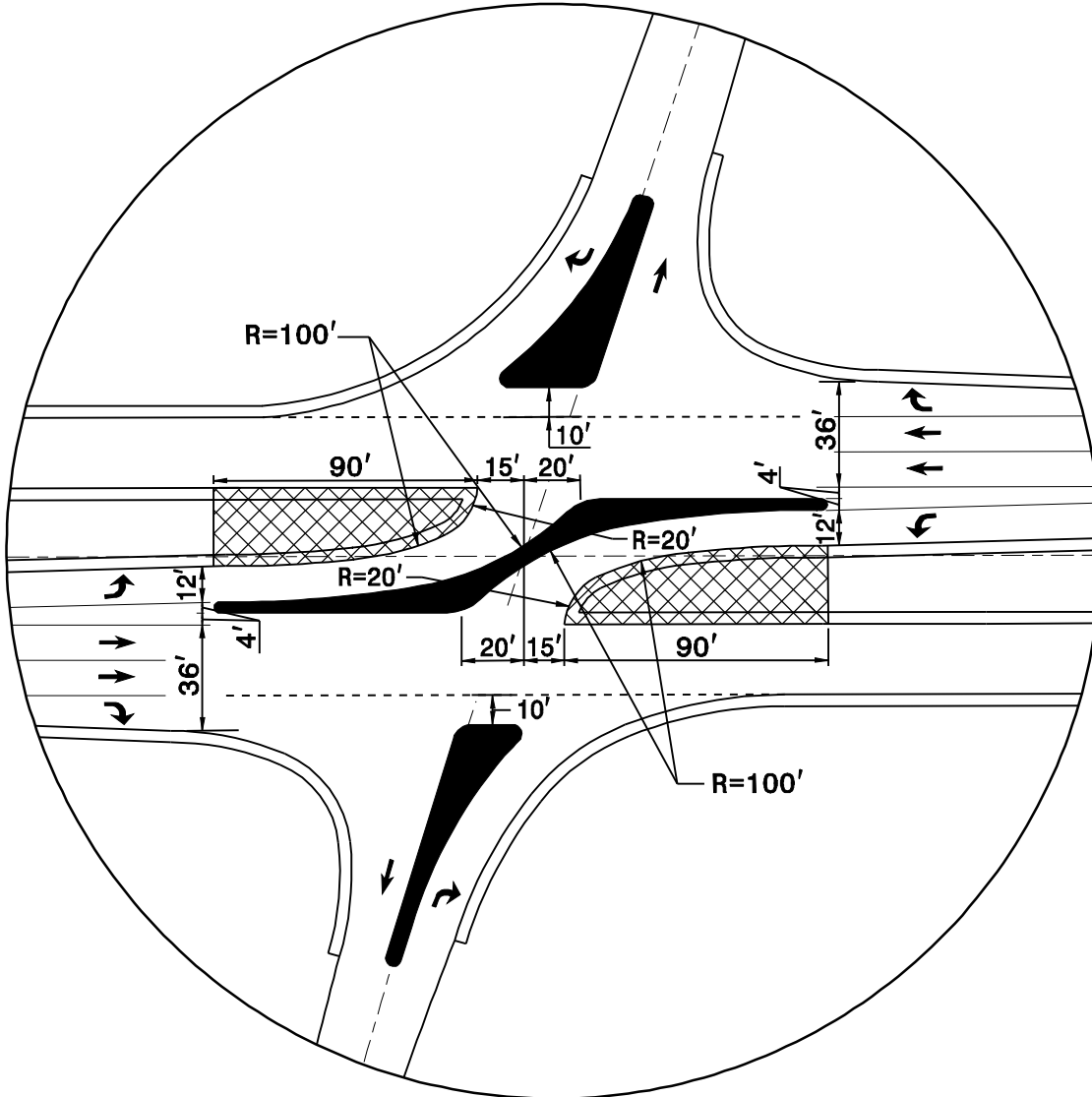

INSET "B"

Revision Date 12/01/05
Revision No. 4

CHAPTER ONE

GENERAL PLAN INFORMATION

LETTERING ON PLANS

1-1

The importance of lettering on plans cannot be emphasized enough. Plans are the media through which the designer communicates his design to the builders. The designer's mission is to be as clear and consistent as possible in communicating construction information on the plans.

Since plans have to be reproduced many times, it is of utmost importance to show lettering on the plans that is not too small, it will not be legible when reduced. Extreme caution shall be taken to refrain from printing over other information that is on the plans. When plans are printed for letting, they are reduced to fifty percent of their original size. Unless acceptable drafting techniques are practiced, the plans will not be legible.

SCALE ON PLANS

1-2

It is suggested that the following scales be used for plotting plan sheets:

1" = 20' & 1" = 50'	On urban type projects and locations where existing topo is congested.
1" = 100'	On new location or in areas with very little topo.
1" = 50'	Interchange details.

CONVENTIONAL SYMBOLS

1-3

All Symbols, Line Styles and Text should be taken from the NCMAP menu. Attributes and comments for use with different scales is discussed in this manual.

STANDARD SHEETS FOR PLAN PREPARATION

1-4

Standard sheets to be utilized in plan preparation are available from CADD. Strict adherence to their use is necessary to maintain conformity in the Roadway Design Unit, Project Services Unit and other units. When deviation from the use of standard sheets is necessary, the Project Engineer shall discuss his proposal with the State Contract Officer.

The standard Highway Design Branch plan sheets are 34 inches wide and 22 inches high. The border lines shall be 3.5 inches from the left edge, 1/2 inch from the right edge and 1/2 inch from the top and bottom edges, making an area 30.0 inches wide by 21 inches high.

All half-size drawings will be reproduced on 11" x 17" paper beginning in July 1996. The information shown should not run over an area 30.0 inches wide by 21 inches high so half size plans can be reproduced on 11" x 17" paper.

CHAPTER TWO
PROJECT NUMBERS

THIS SECTION HAS BEEN INTENTIONALLY LEFT BLANK

CHAPTER THREE

TITLE SHEET

PURPOSE **3-1**

The Title Sheet provides information related to location of project, length of project, and type of work. Specific information to be shown on the title sheet is included below and in the Checklist:

http://www.doh.dot.state.nc.us/preconstruct/highway/dsn_srvc/contracts/standards/checklists/checklist1.html

LOCATION OF PROJECT AND TYPE OF WORK **3-1A**

The location of project and type of work is used repeatedly on various engineering documents throughout the duration of a project. Since the space available on various project documents for writing this information is usually limited, the descriptions for the location and type of work shall be kept to an absolute minimum. In describing the location, the information shall be limited to the county or counties, route, and the beginning and ending points. In listing the type of work, it shall be limited to the major types of construction.

PROJECT LAYOUT **3-1B**

The project layout is a small scale drawing of each plan sheet. The sheet number is shown on each superimposed plan sheet on the layout. This provides a quick reference to a specific location in the plans. The layout should include all interchanges, intersections, service roads, structures, railroads, outstanding geographical features, and any other major landmarks that may be used as reference points.

VICINITY MAP **3-1C**

A vicinity map is required to show sufficient identifying information so that the project may be easily located on a county or state map. The vicinity map may be a tracing of any type map that will provide the most beneficial information. The beginning and ending points of the project should always be shown on the vicinity map. Major transportation facilities convenient for transporting construction materials to the project site should also be shown.

PROJECT NUMBERS ON FINAL PLANS3-1D

A contract number and TIP number is required on the left-hand margin of the title sheet. Use the TIP number at the begin and end project designations on the title sheet. The TIP number will also be used on the title sheet when listing project lengths. WBS elements and Federal Aid Project numbers are to be shown in the upper right hand title block. An example of the title sheet is shown on 3-1E, F-1. Sheets that follow the title sheet require that only the TIP numbers be shown.

INDEX OF SHEETS AND TOTAL SHEET NUMBERS3-1E

The index of sheets is typed on Sheet 1-A. The development of this sheet is done in the Contracts Section of the Design Services Unit.

PLAN SHEET ARRANGEMENT
INDEX OF SHEETS

<u>Sheet Number</u>	<u>Sheet</u>
1	Title Sheet
1-A	Index of Sheets, General Notes, and List of Standards
1-B	Conventional Symbols
1-C	Survey Control Sheets
1-D	Centerline Coordinate List
2, 2-A, 2-B, 2-C, etc.	Typical Sections, Pavement Schedule, and Miscellaneous Details not covered by the Roadway Standards
*3	Summary of Quantities (known as No. 3 Sheet)

Number 3 and the alphabet will be used to organize the sheets that appear below. The alphabetical lettering may be different for each project dependent upon the number of sheets required in this series. Unless unusual conditions are experienced, the suggested order of sheets shall be used. When conditions will not permit, discuss the sheet arrangement with the Plan Review Engineer.

<u>Sheet Number</u>	<u>Sheet</u>
*3 - Series	(Second Sheet) Summary of Drainage Quantities Summary of Guardrail

Rev.. Date 07/12/06

Revision No. 4

INDEX OF SHEETS AND TOTAL SHEET NUMBERS (continued)

3-1E

<u>Sheet Number</u>	<u>Sheet</u>
	Summary of Pavement Removal
	Miscellaneous Removal Summaries
	Earthwork Summary
*3-Series (cont'd)	Parcel Index Sheet (Applicable to projects with more than one plan sheet.)
4	The first plan sheet will always be Number 4. All other plan and profile sheets shall be numbered to fit the project conditions.
TCP-1, TCP-2, etc.	Traffic Control Plans
PM-1, PM-2, etc.	Pavement Marking Plans
E-1, E-2, etc.	Electrical Plan
EC-1, EC-2, etc.	Erosion Control Plans
L-1, L-2, etc.	Landscape Plans
SIGN-1, SIGN-2, etc.	Signing Plans
SIG-1, SIG-2, etc.	Signal Plans
UC-1, UC-2, etc.	Utility Construction Plans
UO-1, UO-2, etc.	Utilities by others Plans
X-1, X-2, etc.	Cross-Sections
X-1A, X-1B, etc.	Cross-Section Summary Sheet
C-1, C-2, C-3, etc.	Culvert Plans
S-1, S-2, S-3, etc.	Structure Plans

Do not show total sheet numbers on the plans.

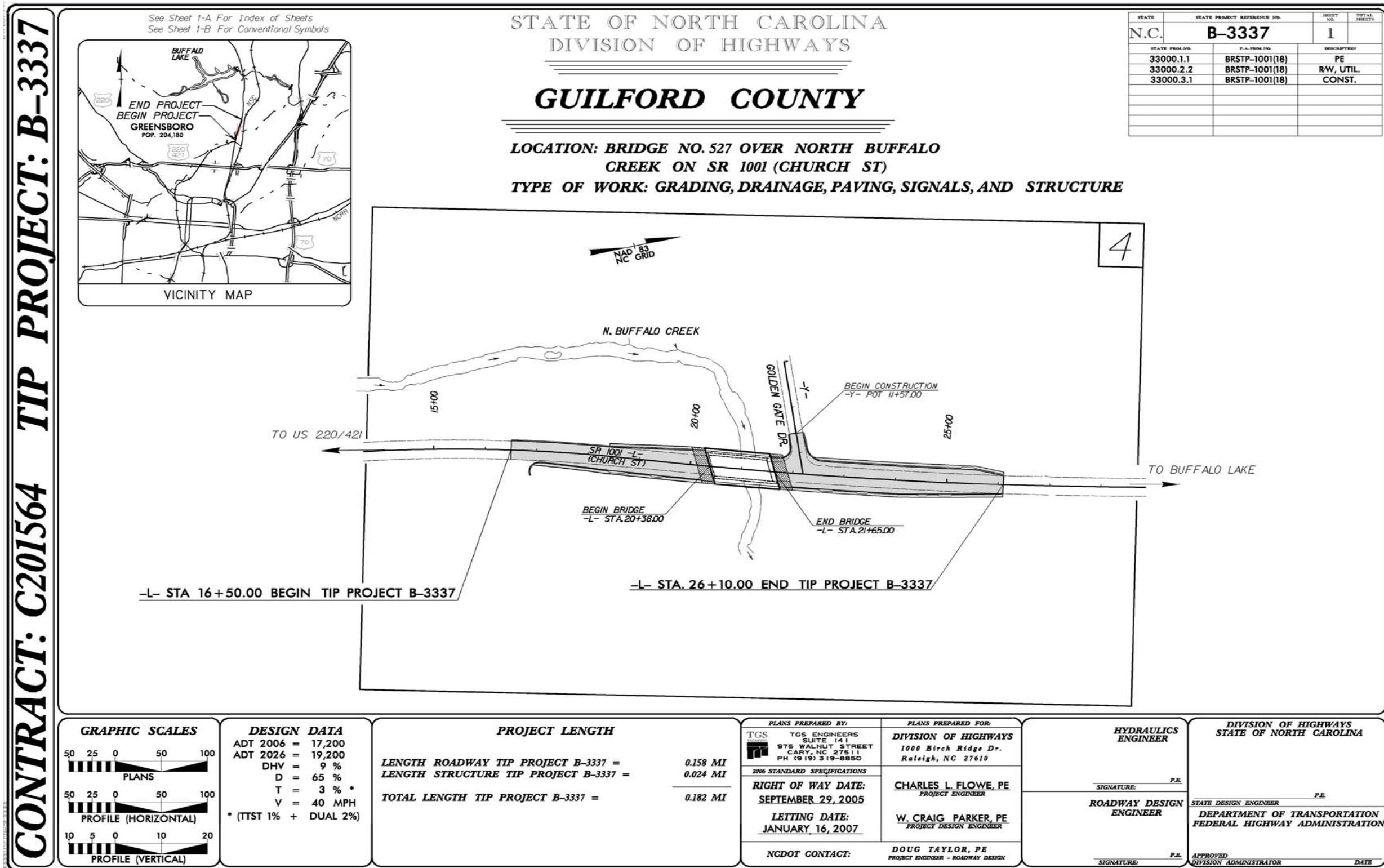

PLANS PREPARED BY3-1F

This information shall be as follows:

John A. Smith, P.E.

Project Engineer

John B. Smith, P.E.

Project Design Engineer

LETTING AND RIGHT OF WAY DATE3-1G

This information shall be as follows:

RIGHT OF WAY DATE:

June 18, 1993

LETTING DATE:

June 21, 1994

CONTROL OF ACCESS NOTE3-1H

This is a controlled-access project with access being limited to interchanges. This is a partial controlled-access project with access being limited to points as shown on the plans.

LENGTH OF PROJECT3-1I

The length of project is broken into roadway lengths and structure lengths. When a box culvert is at least 20' wide, it shall be considered a structure when the length of project is computed. Separate lengths are also computed for the federal aid portion of a project. The length of project is always shown to three decimal places. When the fourth digit is five and above, the third digit will be rounded up. This will correspond with the Structure Design Unit's method of computing structure lengths.

Examples of computing project lengths appear below. When other conditions are experienced, discuss them with the Plan Review Engineer.

PROJECT (WITH STRUCTURES)

Length Roadway TIP Project R-99A = 4.205 Miles

Length Structure TIP Project R-99A = 0.038 Mile

Total Length TIP Project R-99A = 4.243 Miles

LENGTH OF PROJECT (continued)

3-II

PROJECTS (WITHOUT STRUCTURES)

Length Roadway TIP Project R-99A = 4.205 Miles

Total Length TIP Project R-99A = 4.205 Miles

COMBINED PROJECT (WITH STRUCTURES)

Length Roadway TIP Project R-99A/R-99B = 7.708 Miles

Length Structure TIP Project R-99A/R-99B = 0.094 Mile

Total Length TIP Project R-99A/R-99B = 7.802 Miles

COMBINED PROJECT (WITHOUT STRUCTURES)

Length Roadway TIP Project R-99A/R-99B = 3.210 Miles

Total Length TIP Project R-99A/R-99B = 3.210 Miles

COMBINED FEDERAL-AID AND STATE PROJECT (U-83)

Length Roadway TIP Project I-303 = 3.210 Miles

Length Structure TIP Project I-303 = 0.044 Mile

Total Length TIP Project I-303 = 3.254 Miles

Length Roadway TIP Project U-83 = 0.723 Mile

Length Structure TIP Project U-83 = 0.022 Mile

Total Length TIP Project U-83 = 0.745 Mile

Total Length TIP Project I-303/U-83 = 3.999 Miles

DESIGN DESIGNATION

3-IJ

Information related to design should be shown as follows:

ADT	2001	=	25,000	(1)
ADT	2021	=	60,000	(2)
DHV		=	12%	(3)
D		=	60%	(4)
T		=	11% (5%TTST & 6% Dual)	(5)
V		=	60 MPH	(6)

Rev.. Date 07/12/06

Revision No. 4

DESIGN DESIGNATION (continued)

3-IJ

- (1) Average daily traffic is given for the year that a project is let to construction.
- (2) Average daily traffic is given for the design year. The design year is usually twenty years from the letting date.
- (3) Design hourly volume is given as a percentage of ADT which indicates the two way traffic during the 30th highest volume hour in the entire year.
- (4) Directional Split is a percentage of the DHV traveling in the direction of major flow.
- (5) Percent of ADT that is Trucks (TTST* + Duals**)
- (6) V = Design Speed
 - * Truck, Tractor and Semi-Trailer are multi-unit trucks including both single and twin-trailer rig.
 - ** Duals are trucks with at least one dual-tired axle.

PLAN APPROVAL

3-IK

The Roadway Design Project Engineer will be responsible for obtaining the Roadway Design Seal and the Hydraulic Engineer's seal for the Title sheet. The Plan Review Engineer will be responsible for obtaining the signature of the State Highway Design Engineer. The Specifications and Proposals Engineer will be responsible for obtaining the signature of the FHWA Division Administrator, if required. On a state funded project, the signature block for FHWA Division Administrator shall be removed just prior to the plans being submitted to the Plan Review Engineer for final review.

METHOD OF CLEARING

3-IL

Clearing on this project shall be performed to the limits established by Method _____.

This note is to be shown on the Right of Way Plans but removed from the Construction Plans. The note is to be shown on the Title Sheet of the Right of Way Plans. See Roadway Standard, Std. Nos. 200.02 and 200.03.

MUNICIPAL BOUNDARIES

3-IM

One of the following notes is to be shown on the right of way plans. This project is within the municipal boundaries of Town or city. (or) This Project is not within any municipal boundaries. (or) A portion of this project is within the municipal boundaries of Town or city. This note will be removed from the construction plans.

PAVEMENT SCHEDULE (continued)

6-1D

Letter-number combinations shall be used to designate different items having the same code letter and to designate different thickness of the same material.

Descriptions of the various elements shall show thickness, size, rate of application and maximum and minimum thickness per application or layer as applicable. Questions related to pavement design details shall be referred to the Pavement Design Engineer in the Pavement Management Unit.

See 6-ID, Figure 1 for sample pavement schedule.

OPTIONS ITEM LIST

For assembling a pavement schedule, see 6-ID, Figure 1 for an example. The pavement schedule is assembled by utilizing a CADD System. This expanded option items list is plotted by CADD management. Descriptions can be deleted or corrected as needed.

Mix Type	English(Inches)		
	Minimum lift	Maximum lift	Normal total layer
SF9.5A	1.0	1.5	3.0
S9.5X	1.5	2.0	3.0
S12.5X	2.0	2.0	4.0
I19.0X	2.5	4.0	4.0
B25.0X	3.0*	5.5	-

* For B25.0X placed on unstabilized subgrade, minimum lift thickness is 4.0.

PAVEMENT SCHEDULE (continued)

6-1D

The % and type of Asphalt Binder and rate to be used for calculation of quantities are as follows:

Mix Type	% Asphalt Binder	Asphalt Binder Grade	Rate Lbs/SY/in
<u>FRICITION</u>			
OGAFC, TYPE FC-1	6.3	PG 64-22	70 Lbs/SY
OGAFC, TYPE FC-1 MODIFIED	6.3	PG 76-22	70 Lbs/SY
OGAFC, TYPE FC-2 MODIFIED	6.0	PG 76-22	90 Lbs/SY
<u>Surface</u>			
S4.75A	7.0	PG 64-22	100
SF9.5A	6.5	PG 64-22	110
S9.5B	6.0	PG 64-22	112
S9.5C	6.0	PG 70-22	112
S12.5C	5.5	PG 70-22	112
S12.5D	4.8	PG 76-22	112
<u>Intermediate</u>			
I19.0B	4.7	PG 64-22	114
I19.0C	4.7	PG 64-22	114
I19.0D	4.7	PG 70-22	114
<u>Base</u>			
B25.0B	4.3	PG 64-22	114
B25.0C	4.3	PG 64-22	114
PADC, TYPE P-57	2.0	PG 64-22	90
PADC, TYPE P-78M	3.0	PG 64-22	90

NOTE: It is suggested that like pavement mixtures be grouped together in the Pavement Schedule.

PAVEMENT SCHEDULE(continued) 6-ID
 CODE SAMPLE DESCRIPTION F-1

A1 9" Portland Cement Concrete Pavement

A2 8" Continuously Reinforced Concrete Pavement

B Prop. Open-Graded Asphalt Friction Course, Type FC_____, at an Average Rate of _____ lbs. per sq. yd.

For Surface Course

C1 Prop. Approx. _____" Asphalt Concrete Surface Course, Type S_____, at an Average Rate of _____ lbs. per sq. yard.

C2 Prop. Approx. _____" Asphalt Concrete Surface Course, Type S_____, at an Average Rate of _____ lbs. per sq. yard in each of two layers.

C3 Prop. Var. Depth Asphalt Concrete Surface Course, Type S_____, at an Average Rate of _____ lbs. per sq. yard per 1" depth to be placed in layers not to exceed _____" in depth.

For Intermediate Course

D1 Prop. Approx. _____" Asphalt Concrete Intermediate Course, Type I19.0_____, at an Average Rate of _____ lbs. per sq. yard.

D2 Prop. Approx. _____" Asphalt Concrete Intermediate Course, Type I19.0_____, at an Average Rate of _____ lbs. per sq. yard in each of two layers.

D3 Prop. Var. Depth Asphalt Concrete Intermediate Course, Type I19.0_____, at an Average Rate of 114 lbs. per sq. yard per 1" depth to be placed in layers not less than 2 1/4" or greater than 4" in depth.

For Base Course

E1 Prop. Approx. _____" Asphalt Concrete Base Course, Type B_____, at an Average Rate of _____ lbs. per sq. yard.

E2 Prop. Approx. _____" Asphalt Concrete Base Course, Type B_____, at an Average Rate of _____ lbs. per sq. yard in each of two layers.

PAVEMENT SCHEDULE (continued)

6-1D

F-1

- E3 Prop. Var. Depth Asphalt Concrete Base Course, Type B _____, at an Average Rate of 114lbs. per sq. yd. per 1" depth, to be placed in layers not greater than _____" in depth or less than _____" in depth.
- F1 Asphalt Surface Treatment, Mat and Seal.
- F2 Asphalt Surface Treatment, _____
- G Prop. Approx. 8" Cement Treated Base Course (Plant Mixed)
or
 Prop. 8" ABC with the top 7" to be Cement Treated (Road Mixed).
- J1 Prop. 8" Aggregate Base Course
- J2 Prop. 10" Aggregate Base Course
- J3 Prop. Var. Depth Aggregate Base Course
- K Base to be treated with Lime to a depth of 8", at a rate of 20 lbs. per. sq. yd. as directed by the Engineer.
or
 Base to be treated with cement to a depth of 7", at a rate of 55 lbs. per. sq. yd. as directed by the Engineer.
or
 Base to be treated with aggregate at a rate of 250 lbs. per. sq. yd. and cement at a rate of 55 lbs. per. Sq. yd. to a depth of 7" as directed by the Engineer.
- L Base to be stabilized with 200 to 400 lbs. per sq. yard of Stabilizer Aggregate mixed with the top 3" of subgrade soil at locations directed by the Engineer.
- M1 Prop. 8" Soil Type Base Course, Type A
- M2 Prop. 10" Soil Type Base Course, Type _____
- P1 Prime Coat at the rate of .35 gal. per sq. yard.
- P2 Prime Coat at the rate of .50 gal. per sq. yard.
- R1 2'-6" Concrete Curb and gutter
- R2 1'-6" Concrete Curb and Gutter

PAVEMENT SCHEDULE (continued)

6-1D

F-1

- R3 8" x 6" Concrete Curb
- R4 ____" x ____" Concrete Curb
- R5 5" Monolithic Concrete Island (surface mounted)
- R6 5" Monolithic Concrete Island (keyed in)
- R7 3" Concrete Island Cover
- R8 ____" Concrete Island Cover
- S 4" Concrete Sidewalk
- T Earth Material
- U Existing Pavement
- W Variable Depth Asphalt Pavement (See Standard Wedging Detail Sheet No. ____)
- X Permeable Asphalt Drainage Course - Type P- ____

CHAPTER NINE

RIGHT OF WAY

GUIDE FOR ESTABLISHING PROPOSED RIGHT OF WAY

9-1

Proposed right of way will be established and shown on the plans before sending them to the Right of Way Branch for right of way acquisition. The following guides will be used:

1. Interstate, Freeway and Expressway Projects generally have fully controlled access. The right of way should contain the cross-section and allow from 10' to 25' beyond the construction limits. Construction limits are to include slope stakes as well as lateral ditches, berm ditches, erosion control devices, retaining walls, etc.

A typical right of way width for a 4-lane section of this type of roadway would be from 250' to 300' for rural projects and 150' to 200' for urban projects.

2. Rural Arterial and Collector Projects can be controlled access, partial control of access, or no control of access. Generally, right of way should be wide enough to include all cross-sectional elements throughout the project whether a uniform or variable right of way width is used. Right of way should be established from 5' to 15' beyond the construction limits.

A typical right of way width for a 2-lane arterial or collector would be from 100' to 150'. For a 4-lane section of roadway, a width of 150' to 250' would be typical.

3. Urban Arterial Projects may contain the cross-section within the proposed right of way or utilize a combination of right of way and easements. Set right of way or easements a minimum distance of 5' to 15' beyond the construction limits.

Without Curb and Gutter

- a. Cut: set right of way at least 5' outside the ditch bottom.
- b. Fill: set the right of way a minimum of 10' outside the shoulder break.

With Curb and Gutter

Cut and Fill: Right of way needs to contain the berm plus a buffer area.

A typical right of way width for an urban arterial is between 100' to 150' with or without curb and gutter.

GUIDE FOR ESTABLISHING PROPOSED RIGHT OF WAY (continued) 9-1

4. Local Roadway Projects generally have the total cross-section contained within the proposed right of way. In special situations, it may be more economical or preferred by the division to establish a uniform right of way width and utilize easements. Set right of way or easements a minimum distance of 5' to 10' outside the construction limits. Generally, a typical width of 60' to 100' will be adequate.
5. In all situations
 - a. Care should be taken to allow adequate sight distance for street returns and railroad crossings.
 - b. Vehicle recovery area should be considered based on the amount of traffic and the design speed of the facility when establishing the proposed right of way. (See Chapter 1-4M)
 - c. The planning document should be followed.
 - d. The right of way will be reviewed by Division personnel as well as the area right of way personnel prior to acquisition.

RIGHT OF WAY MARKERS ON PLANS

9-2

Right of way markers are installed to mark the highway right of way boundary line. The proposed locations of the markers shall be reviewed at the field inspection and adjustments made as recommended and approved by the Division Right of Way Agent. To fit field conditions, these locations may be further adjusted by the Division Right of Way Agent and Location Engineer during staking operations.

Markers shall be placed at the following locations:

1. Where a deflection occurs in the right of way line. A deflection is at the point where the direction of the right of way line changes with respect to the project reference line.
2. Markers are to be set and placed at a maximum spacing of 1,500 feet. Terrain characteristic and Construction limits may dictate modification.
3. At points on the right of way boundary line where control of access begins and terminates. (Does not apply to partial control of access.)
4. At the beginning and end of the project.
5. Where the right of way is unusual or where clarification of the right of way is necessary.
6. On projects with uniform right of way, the monuments will be shown at the following locations:
 - a. At the P.C. and P.T. of simple curves and PCC of compound curves.
 - b. At P.I.N.C. points (P.I., No curve.)

CHAPTER 19

EARTHWORK

PLOTTING OF CROSS-SECTION SHEETS 19-1

For most projects, cross-sections are plotted on a horizontal and vertical scale of 1"= 5'. On mountainous projects with extremely high cuts and fills 1" = 10' or 1" = 20' might be more practical. In all cases horizontal and vertical scales should be the same. Half-size plots are sent out with plans having over 30 cross-section sheets. Full-size plots are sent out on projects with 30 or less cross-section sheets. If the Division request full-size plots for stake out and construction purposes, these should be provided.

USE OF CADD FOR EARTHWORK 19-2

Most cross sections will be created from a DTM (Digital Terrain Model) originating from Location and Surveys Unit or the Photogrammetry Unit. Geopak can be utilized to plot existing cross-sections, and complete proposed templates and earthwork. (Refer to Geopak Reference Manuals for procedures.)

EARTHWORK BALANCE SHEET 19-3

An earthwork balance sheet is required in the project file. Furnish a copy to the Geotechnical Unit on projects with available subsurface plans. Adhere to the following guidelines when preparing the Earthwork Balance Sheet:

A. BREAKDOWN QUANTITIES AS FOLLOWS:

1. Summary points at every 3,000' ±.
2. Summary points end/begin at each bridge (stream or grade separation).
3. Summary points end/begin near each major at-grade multi-lane intersection or at-grade railroad crossing.
4. Separate Y line, ramp, loop and other major construction items from mainline earthwork, but include in the respective summary.
5. On widening projects, respective summaries are provided for right and left side if the material cannot be hauled across traffic.
6. On existing divided facilities to be widened, respective summaries are provided for right side, left side and median widening if the material cannot be hauled across traffic.
7. Projects with complex construction phasing plans may require phasing of the summary points. Coordinate phasing with the Division and Traffic Engineering.

EARTHWORK BALANCE SHEET (continued)

19-3

- B. Include recommendations from the Geotechnical Unit and/or the Soils and Foundation Section as follows:
1. Shrinkage Factor - Use the figure recommended by the Soils and Foundation Section when available.
 2. Loss Due to Clearing and Grubbing - This volume is estimated for loss in cuts of up to one (1) foot in depth. Any loss in fills is included in the shrinkage factor.
 3. Undercut Excavation - A recommendation for excavating benches at grade points and removing unsuitable material below subgrade. This normally should be wasted, but in certain conditions can be used in embankments.
 4. Top Soil on Borrow Pits - On projects requiring borrow material, an additional 5% of the total borrow should be computed for replacing the top soil on the borrow pit.
 5. Rock – “Hard Rock” is only shown on the Earthwork Balance Sheet. All rock on the project should be used in embankments before using suitable excavation and should be computed on a one-to-one basis unless recommendations specify otherwise.

The earthwork balance sheet, shown in Part II, 19-3, F-2, (with numbered columns) is for use with the descriptions below.

- C. The information for a basic Earthwork Balance Sheet should be listed as follows:
1. List, in column one, the survey line reference and beginning station for each summary point.
 2. Record, in column two, the ending station for each summary point.
 3. Show, in column three, the volume of all material excavated between summary point stations (except material covered by other excavation pay items such as undercut excavation and drainage ditch excavation).
 4. Column four contains volumes of "hard" rock that is excavated as a part of unclassified excavation.
 5. Record, in column five, volumes of material excavated beneath the roadway subgrade.
 6. Show, in column six, volumes of any unclassified excavation that is not suitable for roadway embankments.

CHAPTER 21

PUBLIC HEARINGS

PUBLIC HEARINGS 21-1

Policies and procedures governing public hearings are covered in Chapter 4 of the Policy and Procedure Manual. The actual preparation of the public hearing map is in accordance with instructions that are outlined in Section 21-2.

PREPARATION OF PUBLIC HEARING MAPS 21-2(1) COLOR ACCORDING TO LEGEND (See 21-2, F-1)

- (A) Color buildings and cemeteries inside and outside the proposed R/W even when they are in the proposed roadway pavement.
- (B) The proposed roadway takes precedence over everything except buildings, cemeteries and proposed bridges.
- (C) Show all existing roads that are within the R/W that will be removed.
- (D) Do not color existing drives or parking lots.
- (E) Do not show R/W monuments on a hearing map.
- (F) Proposed R/W takes precedence over Railroad R/W.
- (G) Items that are not being used can be removed from the legend and special items that need to be denoted such as proposed traffic signals, etc. can be added.

(2) LABEL (large enough to be seen easily)

- (A) Show Begin TIP Project in bold, black, capital letters and arrow

Example: **BEGIN TIP PROJECT R-9999**

-L- STA. 10+00.00

- (B) State Lines
- (C) County Lines
- (D) City Limits and Town Limits
- (E) Creeks, Rivers and Lakes
- (F) Railroads
- (G) Landmarks such as Parks, Appalachian Trail, Indian Reservations, Military Bases, Subdivision Names, etc. (Label in bold, black letters).
- (H) Historic Properties (outline property lines in bold, black, mini-skip lines and label "Historic Property" in bold, black letters).

PREPARATION OF PUBLIC HEARING MAPS (continued)

21-2

- (I) Property owners and property lines (If properties are small parcels, consider assigning a parcel number to each and set up a table on the hearing map listing the owners. Care should be taken to avoid covering property owner's names and house, etc.)
 - (J) Show -L- and -Y- line designations and the road/street route number with common name in bold, black letters.
Examples: **-L- PROPOSED US 17 BYPASS; -Y5- NC 49 (YORK ROAD)**
 - (K) Cemeteries (Show name of it if available.)
 - (L) Show Wetland Boundaries (labeled as WLB) and Stream Buffers, if applicable (labeled as BZ).
 - (M) Widths of proposed roadway, proposed median width, existing and/or proposed right of way width at each end of the map.
 - (N) Label the Slope Stake Line with (C) and (F) as appropriate.
 - (O) Show Existing Traffic Signals and Proposed Traffic Signals to be installed within 5 years after project letting.
 - (P) Label mainline stations @ 500' or 100 m intervals in bold, black letters.
 - (Q) Show destination of roads if there is a city, town or major road nearby.
Examples: **To Greensboro, To I-77, etc.**
 - (R) Show End TIP Project in bold, black, capital letters and arrow
Example: **END TIP PROJECT R-9999**
-L- STA. 90+00.00
- (3) DESIGN INFORMATION TO BE SHOWN:
- (A) Show North arrow, graphic scale of map with either English or Metric unit designation identified under the graphic scale and map legend at intervals of approximately six (6) feet.
NOTE: For the full size hearing map, please consider a scale of 1" = 100'(1:1000 in metric units) for "curb type" urban widening projects and a scale of 1"= 200'(1:2000 or 1:2500 in metric units) for rural, new location projects.
 - (B) Show typical sections of -L- mainline for each significantly different location or area. Show lane usage on typicals.
(See 21-2, F-2).
 - (C) Show typical sections of major -Y- lines and show lane usage on typicals.
 - (D) Show a box with the Functional Classification of the proposed mainline; Design Speed and maximum superelevation chart used for the horizontal alignment.

PREPARATION OF PUBLIC HEARING MAPS (continued)

21-2

Example: Functional Class. = Arterial
Design Speed = 60 mph
Max. Superelev. = 0.08

- (E) Show a box with current and design year traffic volumes with turning movements shown as the actual count; not listed in hundred's.
- (F) At intersections, show lane usage arrows. Show them either directly on the proposed roadway if scale permits or show as a separate diagram.
- (G) Show on-site detours and associated easements that may be required to construct a major structure or a major grade change. Show the detour on the map and provide a typical section. An off-site detour is sometimes proposed to maintain traffic during construction, then consideration should be given to identifying the proposed route on a vicinity map inset shown on the hearing map.
- (H) Show horizontal curve data for the mainline -L- alignment and alignments for major -Y- lines. Please identify the horizontal curve points (PC, PT, ST, SC, etc.) on the map. Show station marks on all alignments every 100' for English projects and at 20 m increments for metric projects.
- (I) If there are areas on the project where special commitments have been made to avoid impacts to a grove of trees, special landscaping, special walls or a small portion of a pond not to be disturbed, please label the general area or specific location "DO NOT DISTURB".
- (J) " PRELIMINARY - DO NOT USE FOR CONSTRUCTION " labels need to be on the map. Spacing should be the same as North arrow, scale and legend, approximately six (6) feet.
- (K) Show the following project identification on the inside of each hearing map and a smaller version of the identification on the outside of both ends of the Public Hearing Map - to be read while map is rolled up.
 - Corridor, Design or Combined Public Hearing Map, whichever applies to the project.
 - State and Federal Project Numbers with TIP Identification Number
 - County
 - Route Number and Location Description
 - Seal of North Carolina
 - Seal of NCDOT

PREPARATION OF PUBLIC HEARING MAPS (continued)

21-2

- (L) For projects using curb and gutter, show driveway curb cuts. Follow the "Driveway Manual" regarding the number of driveway access points allowed, but also use common sense and engineering judgement in replacing existing driveways. Do not include driveways and designated access points on undeveloped property.
- (M) Median Crossover Openings will be shown on the hearing map according to the Median Crossover Guidelines. **Intermediate crossover locations should not be shown on the hearing map, unless reviewed and approved by the State Highway Design Engineer.** Close coordination between the Highway Design Branch, Roadway Design Unit, Congestion Management Section of Traffic Engineering and the Division should take place in selecting the type of crossover design.
- (N) Show and label noise abatement measures that have been recommended in the planning document and/or Design Noise Report.
- (O) If Control of Access is involved whether it is existing C/A, partial C/A, or full C/A, identify the limits and type of the control of access. On partial C/A projects, add the following note to the hearing map: **"Partial Control of Access is defined as one access point per parcel. For properties with large road frontages (for example, 2000 feet or more), an additional access point may be considered. For properties that have access, such as via a side road, access to *insert mainline name (e.g. US 601)* may be eliminated."**
- (P) If sidewalk is proposed throughout the project, there is no need to show it on the hearing map plan, however, it does need to be shown on the typical section. If sidewalk limits are at random locations such as partially on one side and/or in areas where it is not continuous, then it would be a good practice to show the locations on the hearing map plan. Existing sidewalk should be shown in all cases.

(4) HEARING PREPARATION

- (A) Prepare an informational sheet for a Hearing Map Review. (See 21-2, F-3).
- (B) Set-up and hold a Hearing Map Review. (See 21-3)
- (C) Make sure the hearing map, which is presented to the public, has a well-defined black border around the edges. This can either be plotted with a wide, black border around the perimeter and reinforced with transparent tape or reinforce the edges with black masking tape. Half-size copies of the hearing map are not required to be taped.

PREPARATION OF PUBLIC HEARING MAPS (continued)

21-2

- (D) Review the planning document to make sure it agrees with the design shown on the hearing map.
- (E) Develop a very general traffic control concept to take to the public hearing if needed. Consult with the Division concerning how they think the project will be constructed. (See Part II, Chapter 12 of this Manual).
- (F) Take the preliminary grades and cross-sections to the public hearing for information in helping to explain impacts to the public if this need arises.
- (G) Develop a general knowledge of other area projects. It may be a good idea to take your TIP books to the hearing to help answer this type of inquiry.
- (H) Consider taking a list of key people such as the DOT Board Member(s), Division Engineer, Division Construction, Maintenance and Traffic Engineers, Division R/W Agent and LPO contact, etc. with telephone numbers and/or e-mail addresses who are involved with the project. Sometimes additional questions regarding other area TIP projects, maintenance and drainage issues, etc. are asked where a contact person is beneficial to those concerned.

